



DOUILLES À CHOC POUR UNE PERFORMANCE ET UNE SÉCURITÉ OPTIMALE

www.rami-yokota.com



• **Douilles à choc
et accessoires**

• Normales/Longues

• Magnétiques/Torx®

• Empreinte 6-Pans

• 12-Pans

• Surface Drive

• Paroi mince

• Triple carré / Profil Ribe

• Cardan 6-Pans

• Douilles guidées

• Jeux douilles à choc

• Couple/Adaptateurs

• Rallonges



Sommaire

Action	
	A propos d'Action 3
Douilles à choc pour visseuses	
1/4"	6-Pans & Douille porte-taraud 4
Action douilles à choc	
1/4"	6-Pans normales 5 6-Pans profonde Torx® Surface Drive Cardan 6-Pans
3/8"	6-Pans normales 8 6-Pans profonde 12-Pans normales 12-Pans profonde Surface Drive Torx® Empreinte 6-Pans / Carré triple Cardan Profil Ribe Douille porte-taraud
1/2"	4-Pans / Douille octagonal 14 6-Pans normales 6-Pans profonde 12-Pans normales 12-Pans profonde Surface Drive Torx® 6-Pans Cardan Empreinte 6-Pans / Carré triple Profil Ribe Douille porte-taraud Prise goujon
3/4"	4-Pans 24 6-Pans normales 6-Pans profonde Empreinte 6-Pans 8-Pans 12-Pans normales 12-Pans profonde Torx® Prise goujon
1"	4-Pans 28 6-Pans normales 6-Pans profonde 8-Pans 12-Pans normales 12-Pans profonde Empreinte 6-Pans (Inbus)
1 1/2"	6-Pans normales 32 6-Pans profonde Empreinte 6-Pans (Inbus)
2 1/2"	6-Pans normales 33
#5	6-Pans 33
Adaptateurs	
	Rallonges 34 Mandrin à chocs Rallonges Wobble Cardans Adaptateurs Mandrin à chocs
Douilles guidées	
3/8"	6-Pans normales 37 6-Pans longues 6-Pans profonde Torx® Empreinte 6-Pans
1/2"	6-Pans normales 39 6-Pans longues 6-Pans profonde Torx® Empreinte 6-Pans Prise Goujon
3/4"	6-Pans normales 41 Empreinte 6-Pans Torx® Rallonges Adaptateurs
Jeux de douilles à choc	
	Jeu de douilles pour boulon 43 de roue extra longues

A propos d'Action



Carré d'entraînement

Les douilles impact Action sont disponibles avec des carrés d'entraînement de taille 1/4" jusque 2 1/2". La forme du carré d'entraînement de ces douilles est caractérisée par les coins arrondis, ainsi le carré d'entraînement de la visseuse a le meilleur positionnement possible. Ceci entraîne un couple de serrage transmis sur une large surface et non seulement dans les coins de la douille. Il résulte ainsi une bonne endurance des douilles et une longue durée de vie.



Douilles 6-Pans

Les douilles 6-Pans fabriquées par Action ont aussi des coins arrondis. Les coins arrondis permettent de l'espace pour la tête de vis 6-pans, ainsi le couple de serrage est transmis sur les flancs de la tête de vis, donnant de meilleurs résultats. L'entraînement des flancs signifie aussi que l'usure des flancs sur les pans de la tête de vis ou du boulon est réduite. Pour les douilles 12-Pans une géométrie similaire est utilisée.

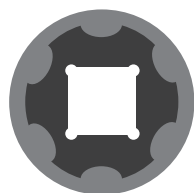

Douilles Surface Drive

Les douilles Surface Drive sont conçues pour entraîner seulement le centre des flancs de la tête de vis ou du boulon. Les douilles Surface Drive doivent être recommandées pour une utilisation avec des boulons à pans usés, mais aussi pour des boulons avec des matériaux plus tendres et des têtes de vis ou boulons polis.

Douilles guidées (Sleeve Drive)

Les douilles Sleeve Drive ont été développées par Action à la demande de Yokota pour améliorer la qualité d'un assemblage vissé avec des visseuses à impulsions.

Les douilles Sleeve Drive minimise le jeu entre la douille et la visseuse réduisant ainsi l'oscillation et stabilisant le couple réglé. L'utilisation des douilles Sleeve Drive améliore la qualité d'assemblage et réduit aussi la vibration dans la visseuse et dans la main de l'opérateur. On note également une réduction du bruit et de l'usure de l'outil.

Des douilles usées sont la cause de perte de puissance, usure du carré d'entraînement de l'outil et augmentation des vibrations et bruits pour l'opérateur.

Remplacer vos douilles usées à temps.

Attention!

Toujours porter des lunettes de sécurité en utilisant des outils à chocs. Ne pas tenir la douille pendant l'utilisation.

Toutes les douilles à chocs Action sont usinées selon les normes DIN 3121 et DIN 3129.

Les douilles à cardan et à paroi mince sont fournies sans garantie.

La réglementation européenne, Directive des machines 2006/42/EG et EN/ISO 11148-6, statue que seules les douilles à chocs sont à utiliser avec des visseuses motorisées.

Si vous ne pouvez trouver les dimensions et tailles requises pour votre application dans ce catalogue, contactez nous!

Douilles à choc pour visseuses

1/4"

TAILLE 6-Pans

Type	C/P mm	Dessin	D1 mm	L mm	L1 mm	-
------	--------	--------	-------	------	-------	---

Métriques

DO697B0S04	4	A	8	55	4,5	-
DO697B0S06	6	A	10	55	4,5	-
DO697B0T06	6	A	10	75	4,5	-
DO697B0T07	7	A	11	75	4,5	-
DO697B0T08	8	A	12	75	4,5	-
DO697B0T10	10	A	14	75	5,5	-
DO697B0T12	12	A	17	75	5,5	-
DO697B0T13	13	A	18	75	5,5	-
DO697B0T14	14	A	19	75	5,5	-

TAILLE 6-Pans magnétique

Type	C/P mm	Dessin	D1 mm	L mm	L1 mm	-
------	--------	--------	-------	------	-------	---

Métriques

DO697B0M06	6	B	10	55	4,5	-
DO697B0M08	8	B	12	55	4,5	-
DO697B0M10	10	B	14	55	5,5	-
DO697B0M12	12	B	17	55	5,5	-
DO697B0M13	13	B	18	55	5,5	-
DO697B0M14	14	B	19	55	5,5	-
DO697B0P06	6	B	10	100	4,5	-
DO697B0P08	8	B	12	100	4,5	-
DO697B0P10	10	B	14	100	5,5	-
DO697B0P12	12	B	17	100	5,5	-
DO697B0P13	13	B	18	100	5,5	-
DO697B0P14	14	B	19	100	5,5	-

TAILLE 6-Pans profonde magnétique

Type	C/P mm	Dessin	D1 mm	L mm	L1 mm	-
------	--------	--------	-------	------	-------	---

Métriques

DO697B7006	6	C	10	100	4,5	-
DO697B7008	8	C	12	100	4,5	-
DO697B7010	10	C	14	100	5,5	-
DO697B7012	12	C	17	100	5,5	-
DO697B7013	13	C	18	100	5,5	-
DO697B7014	14	C	19	100	5,5	-
DO697B9006	6	C	10	200	4,5	-
DO697B9008	8	C	12	200	4,5	-
DO697B9010	10	C	14	200	5,5	-
DO697B9012	12	C	17	200	5,5	-
DO697B9013	13	C	18	200	5,5	-
DO697B7014	14	C	19	200	5,5	-

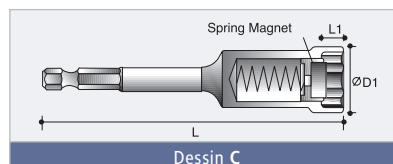
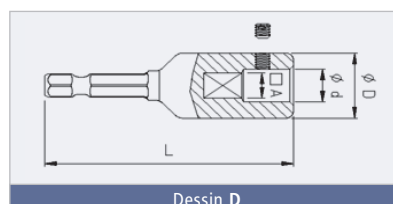
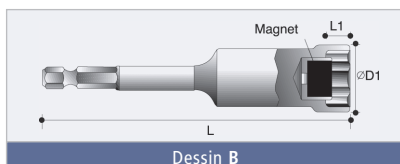
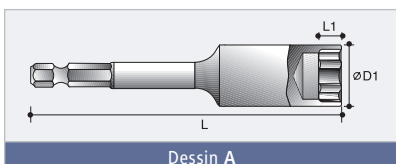

TAILLE Douille porte-taroud

Type	□A mm	Dessin	Ø d mm	Ø D mm	L mm	-
------	-------	--------	--------	--------	------	---

Métriques

DO63A65001	3,4	D	4,5	14	55	-
DO63A65002	4,9	D	6,0	15	55	-
DO63A65003	5,5	D	7,0	16	55	-
DO63A65004	6,2	D	8,0	17	60	-
DO63A65005	7,0	D	9,0	18	70	-
DO63A65006	8,0	D	10,0	19	70	-
DO63A65007	9,0	D	11,0	20	70	-
DO63A65008	9,0	D	12,0	21	70	-
DO63A65009	11,0	D	14,0	23	75	-

Exemple d'application



Douilles à choc

1/4"



1



2



3



4

TAILLE						
6-Pans normales						1
Type	C/P mm	Dessin	D1 mm	D2 mm	L mm	L2 mm
Métriques						
DO0014-0-004	4	A	7,6	13	23	4
DO0014-0-0045	4,5	A	8,2	13	23	5
DO0014-0-005	5	A	8,8	13	23	5
DO0014-0-0055	5,5	A	9,5	13	23	5
DO0014-0-006	6	A	10	13	23	6
DO0014-0-007	7	A	11,3	13	23	6
DO0014-0-008	8	A	12,5	13	23	7
DO0014-0-009	9	A	13,8	13	23	7
DO0014-0-010	10	C	15	13	23	7
DO0014-0-011	11	C	16,3	13	23	8
DO0014-0-012	12	C	17	13	23	8
DO0014-0-013	13	C	18,8	13	23	8
DO0014-0-014	14	C	20	13	23	8
DO0014-0-015	15	C	21	13	23	8

TAILLE						
6-Pans normales						1
Type	C/P mm	Dessin	D1 mm	D2 mm	L mm	L2 mm
SAE						
DO0014-0-3/16	3/16"	A	8,5	13	23	5
DO0014-0-1/4	1/4"	A	10,3	13	23	6
DO0014-0-5/16	5/16"	A	12,5	13	23	7
DO0014-0-3/8	3/8"	C	15	13	23	7
DO0014-0-7/16	7/16"	C	16,3	13	23	8
DO0014-0-1/2	1/2"	C	18,8	13	23	8

TAILLE						
6-Pans profonde						2
Type	C/P mm	Dessin	D1 mm	D2 mm	L mm	L2 mm
Métriques						
DO0014-1-004	4	A	8,2	13	50	4
DO0014-1-045	4,5	A	8,2	13	50	6
DO0014-1-005	5	A	8,8	13	50	6
DO0014-1-006	6	A	10	13	50	7
DO0014-1-007	7	A	11,3	13	50	7
DO0014-1-008	8	A	12,5	13	50	9
DO0014-1-009	9	C	13,8	13	50	9
DO0014-1-010	10	C	15	13	50	9
DO0014-1-011	11	C	16,3	13	50	9
DO0014-1-012	12	C	17	13	50	9
DO0014-1-013	13	C	18,8	13	50	9
DO0014-1-014	14	C	20	13	50	9
DO0014-1-015	15	C	21	13	50	9

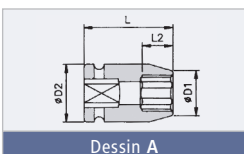

Dessin A

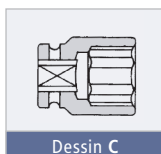

Dessin C

TAILLE						
6-Pans normales magnétique						3
Type	C/P mm	Dessin	D1 mm	D2 mm	L mm	L2 mm
Métriques						
DO6050P050	5	A	8,8	13	23	3
DO6050P055	5,5	A	9,5	13	23	3
DO6050P060	6	A	10	13	23	3
DO6050P070	7	A	11,3	13	23	3
DO6050P080	8	A	12,5	13	23	3
DO6050P090	9	C	13,8	13	23	4
DO6050P100	10	C	15	13	23	4
DO6050P110	11	C	16,3	13	23	5
DO6050P120	12	C	17	13	23	5
DO6050P130	13	C	18,8	13	23	5
DO6050P140	14	C	20	13	23	6
DO6050P150	15	C	21	13	23	6

TAILLE						
6-Pans profonde magnétique						4
Type	C/P mm	Dessin	D1 mm	D2 mm	L mm	L2 mm
Métriques						
DO6050R050	5	A	8,8	13	50	3
DO6050R055	5,5	A	9,5	13	50	3
DO6050R060	6	A	10	13	50	3
DO6050R070	7	A	11,3	13	50	3
DO6050R080	8	A	12,5	13	50	3
DO6050R090	9	C	13,8	13	50	4
DO6050R100	10	C	15	13	50	4
DO6050R110	11	C	16,3	13	50	5
DO6050R120	12	C	17	13	50	5
DO6050R130	13	C	18,8	13	50	5
DO6050R140	14	C	20	13	50	6
DO6050R150	15	C	21	13	50	6

Douilles à choc



Douille Torx®

□ 1/4"

TAILLE							1
Torx® intérieure							
Type	C/P	Dessin	D2 mm	L1 mm	L mm	-	
DO64701005	T5	F	13	2,0	35	-	
DO64701006	T6	F	13	2,0	35	-	
DO64701007	T7	F	13	2,0	35	-	
DO64701008	T8	F	13	2,0	35	-	
DO64701009	T9	F	13	2,0	35	-	
DO64701010	T10	F	13	2,8	35	-	
DO64701015	T15	F	13	2,8	35	-	
DO64701020	T20	F	13	2,8	35	-	
DO64701025	T25	F	13	3,0	35	-	
DO64701027	T27	F	13	3,0	35	-	
DO64701030	T30	F	13	3,8	35	-	

Torx® est une marque commerciale de Textron.

TAILLE							1
Torx® Tamper Resistant intérieure							
Type	C/P	Dessin	D2 mm	L1 mm	L mm	-	
DO64706008	T8	F	13	2,0	35	-	
DO64706009	T9	F	13	2,0	35	-	
DO64706010	T10	F	13	2,8	35	-	
DO64706015	T15	F	13	2,8	35	-	
DO64706020	T20	F	13	2,8	35	-	
DO64706025	T25	F	13	3,0	35	-	
DO64706027	T27	F	13	3,0	35	-	
DO64706030	T30	F	13	3,8	35	-	

Torx® est une marque commerciale de Textron.

TAILLE							2
Torx® extérieure							
Type	C/P	Dessin	D1 mm	D2 mm	L mm	L2 mm	
DO63300004	E4	A	7,2	13	25	4	
DO63300005	E5	A	8	13	25	4,5	
DO63300006	E6	A	9	13	25	5	
DO63300007	E7	A	9,5	13	25	6	
DO63300008	E8	A	10	13	25	6	
DO63300010	E10	A	12,5	13	25	7,5	
DO63300011	E11	B	13	13	25	8	
DO63300012	E12	B	14,5	14,5	25	8,5	

Torx® est une marque commerciale de Textron.

TAILLE							3
Torx® à paroi mince extérieure							
Type	C/P	Dessin	D1 mm	D2 mm	L mm	L2 mm	
DO63305004	E4	A	6,5	13	25	4	
DO63305005	E5	A	7,5	13	25	4,5	
DO63305006	E6	A	8,5	13	25	5	
DO63305007	E7	A	9	13	25	6	
DO63305008	E8	A	9,8	13	25	6	
DO63305010	E10	A	12	13	25	6,5	
DO63305011	E11	A	12,7	13	25	8	
DO63305012	E12	A	14	14,5	25	8,5	

Les douilles à cardan sont sécurisées par une bague.

Torx® est une marque commerciale de Textron.



1



2



3

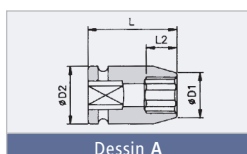

Dessin A

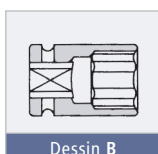

Dessin B

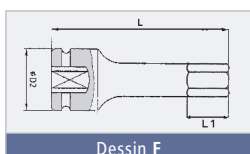

Dessin F

Douilles à choc



Surface Drive

□ 1/4"



1



2



3

TAILLE

Surface Drive normales



1

Type	C/P mm	Dessin	D1 mm	D2 mm	L mm	L2 mm
------	--------	--------	-------	-------	------	-------

Métriques

DO63405040	4	A	7,6	13	23	4
DO63405045	4,5	A	8,2	13	23	5
DO63405050	5	A	8,8	13	23	5
DO63405055	5,5	A	9,5	13	23	5
DO63405060	6	A	10	13	23	6
DO63405070	7	A	11,3	13	23	6
DO63405080	8	A	12,5	13	23	7
DO63405090	9	C	13,8	13	23	7
DO63405100	10	C	15	13	23	7
DO63405110	11	C	16,3	13	23	8
DO63405120	12	C	17	13	23	8
DO63405130	13	C	18,8	13	23	8
DO63405140	14	C	20	13	23	8
DO63405150	15	C	21	13	23	8

TAILLE

Cardan 6-Pans normales



3

Type	C/P mm	Dessin	D1 mm	D2 mm	L mm	L2 mm
------	--------	--------	-------	-------	------	-------

Métriques

DO62500050	5	E	8,8	15	43	5
DO62500055	5,5	E	9,5	15	43	6
DO62500060	6	E	10	15	43	6
DO62500070	7	E	11,5	15	43	8
DO62500080	8	E	12,5	15	43	8
DO62500090	9	E	14	15	43	8
DO62500100	10	E	15	15	43	8
DO62500110	11	E	16,5	15	43	8
DO62500120	12	E	16,8	16	48	8
DO62500130	13	E	18,8	16	48	8
DO62500140	14	E	19,8	16	48	8
DO62500150	15	E	20,8	16	48	8

TAILLE

Surface Drive profonde



2

Type	C/P mm	Dessin	D1 mm	D2 mm	L mm	L2 mm
------	--------	--------	-------	-------	------	-------

Métriques

DO63407040	4	A	7,6	13	50	4
DO63407045	4,5	A	8,2	13	50	6
DO63407050	5	A	8,8	13	50	6
DO63407055	5,5	A	9,5	13	50	6
DO63407060	6	A	10	13	50	7
DO63407070	7	A	11,3	13	50	7
DO63407080	8	A	12,5	13	50	9
DO63407090	9	C	13,8	13	50	9
DO63407100	10	C	15	13	50	9
DO63407110	11	C	16,3	13	50	9
DO63407120	12	C	17	13	50	9
DO63407130	13	C	18,8	13	50	9
DO63407140	14	C	20	13	50	9
DO63407150	15	C	21	13	50	9

Joint torique clavette

DO1014-0-000

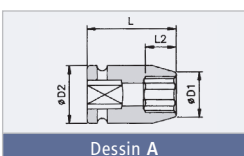

Dessin A

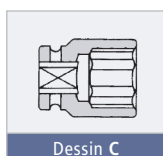

Dessin C

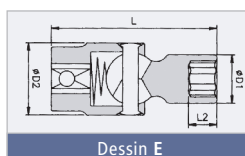

Dessin E

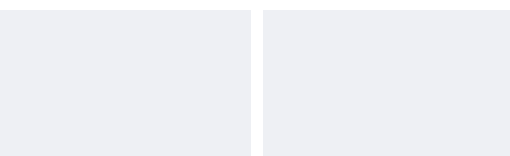

Douilles à choc

□ 3/8

TAILLE

6-Pans normales

Type	C/P mm	Dessin	D1 mm	D2 mm	L mm	L2 mm
------	--------	--------	-------	-------	------	-------

Métriques

DO1038-0-006	6	A	11	19	30	4
DO1038-0-007	7	A	12,5	19	30	8
DO1038-0-008	8	A	14	19	30	8
DO1038-0-009	9	A	15	19	30	8
DO1038-0-010	10	A	16	19	30	8
DO1038-0-011	11	A	17,5	19	30	9
DO1038-0-012	12	B	19	19	30	9
DO1038-0-013	13	A	20	22	30	9
DO1038-0-014	14	A	21	22	30	9
DO1038-0-015	15	B	22	22	30	11
DO1038-0-016	16	C	24	22	30	11
DO1038-0-017	17	C	25	22	30	11
DO1038-0-018	18	C	26	22	30	11
DO1038-0-019	19	C	27,5	22	30	11
DO1038-0-020	20	C	28	22	30	12
DO1038-0-021	21	C	30	22	30	13
DO1038-0-022	22	C	32	23	30	13
DO1038-0-023	23	C	33	23	30	13
DO1038-0-024	24	C	34	23	30	13

TAILLE

6-Pans normales

Type	C/P Pouce	Dessin	D1 mm	D2 mm	L mm	L2 mm
------	-----------	--------	-------	-------	------	-------

SAE

DO1038-0-5/16	5/16"	A	12,5	19	30	8
DO1038-0-3/8	3/8"	A	14,5	19	30	8
DO1038-0-7/16	7/16"	A	17	19	30	9
DO1038-0-1/2	1/2"	B	19	19	30	9
DO1038-0-9/16	9/16"	B	20	20	30	9
DO1038-0-5/8	5/8"	B	24	24	30	11
DO1038-0-11/16	11/16"	B	24	24	30	11
DO1038-0-3/4	3/4"	B	26	26	30	11
DO1038-0-13/16	13/16"	B	28	28	30	13
DO1038-0-7/8	7/8"	B	30	30	30	13
DO1038-0-15/16	15/16"	B	34	34	30	13

TAILLE

6-Pans normales magnétique

Type	C/P mm	Dessin	D1 mm	D2 mm	L mm	L2 mm
------	--------	--------	-------	-------	------	-------

Métriques

DO6051P006	6	A	11,5	19	30	3
DO6051P007	7	A	12,5	19	30	3
DO6051P008	8	A	14	19	30	3
DO6051P009	9	A	15	19	30	4
DO6051P010	10	A	16,5	19	30	4
DO6051P011	11	A	17,5	19	30	5
DO6051P012	12	B	19	19	30	5
DO6051P013	13	A	20	22	30	5
DO6051P014	14	A	21,5	22	30	6
DO6051P015	15	B	22	22	30	6
DO6051P016	16	C	24	22	30	6
DO6051P017	17	C	25	22	30	6
DO6051P018	18	C	26	22	30	7
DO6051P019	19	C	27,5	22	30	7

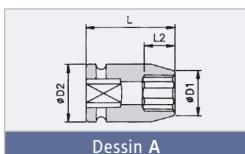

Dessin A

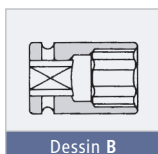

Dessin B

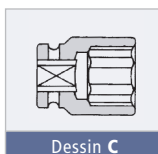

Dessin C



1



2



3

Douilles à choc

□ 3/8



1



2



3



4

TAILLE						
6-Pans profonde						
Type	C/P mm	Dessin	D1 mm	D2 mm	L mm	L2 mm

Métriques						
DO1038-1-007	7	A	12,5	19	65	12
DO1038-1-008	8	A	13,8	19	65	12
DO1038-1-009	9	A	15	19	65	12
DO1038-1-010	10	A	16	19	65	12
DO1038-1-011	11	A	17,5	19	65	25
DO1038-1-012	12	B	19	19	65	25
DO1038-1-013	13	A	20	22	65	25
DO1038-1-014	14	A	21	22	65	25
DO1038-1-015	15	B	22	22	65	25
DO1038-1-016	16	C	24	22	65	25
DO1038-1-017	17	C	25	22	65	25
DO1038-1-018	18	C	26	22	65	25
DO1038-1-019	19	C	27,5	22	65	25
DO1038-1-020	20	C	28	22	65	25
DO1038-1-021	21	C	30	22	65	25
DO1038-1-022	22	C	32	23	65	25
DO1038-1-024	24	C	34	23	65	25

TAILLE						
6-Pans profonde magnétique						
Type	C/P mm	Dessin	D1 mm	D2 mm	L mm	L2 mm

Métriques						
DO6051R006	6	A	11,5	19	55	3
DO6051R007	7	A	12,5	19	55	3
DO6051R008	8	A	14	19	55	3
DO6051R009	9	A	15	19	55	4
DO6051R010	10	A	16,5	19	55	4
DO6051R011	11	A	17,5	19	55	5
DO6051R012	12	B	19	19	55	5
DO6051R013	13	A	20	22	55	5
DO6051R014	14	A	21,5	22	55	6
DO6051R015	15	B	22	22	55	6
DO6051R016	16	C	24	22	55	6
DO6051R017	17	C	25	22	55	6
DO6051R018	18	C	26	22	55	7
DO6051R019	19	C	27,5	22	55	7

TAILLE						
12-Pans normales						
Type	C/P mm	Dessin	D1 mm	D2 mm	L mm	L2 mm

Métriques						
DO65815006	6	A	11	19	30	5
DO65815007	7	A	12	19	30	8
DO65815008	8	A	13	19	30	8
DO65815009	9	A	15	19	30	8
DO65815010	10	A	16	19	30	8
DO65815011	11	A	17,5	19	30	9
DO65815012	12	A	18,5	19	30	9
DO65815013	13	A	20	22	30	10
DO65815014	14	A	21	22	30	11
DO65815015	15	B	22	22	30	12
DO65815016	16	C	24	22	30	12
DO65815017	17	C	25	22	30	12
DO65815018	18	C	26	22	30	13
DO65815019	19	C	27	22	30	13
DO65815020	20	C	28	22	30	13
DO65815021	21	C	30	22	30	14
DO65815022	22	C	31	23	30	15
DO65815023	23	C	32	23	30	15
DO65815024	24	C	34	23	30	16
DO65815025	25	C	35	23	30	16
DO65815026	26	C	36	23	30	16

TAILLE						
12-Pans profonde						
Type	C/P mm	Dessin	D1 mm	D2 mm	L mm	L2 mm

Métriques						
DO65817006	6	A	11	19	63	5
DO65817007	7	A	12	19	63	12
DO65817008	8	A	13	19	63	12
DO65817009	9	A	15	19	65	12
DO65817010	10	A	16	19	65	22
DO65817011	11	A	17,5	19	65	22
DO65817012	12	A	18,5	19	65	22
DO65817013	13	A	20	22	65	22
DO65817014	14	A	21	22	65	22
DO65817015	15	B	22	22	65	22
DO65817016	16	C	24	22	65	24
DO65817017	17	C	25	22	65	24
DO65817018	18	C	26	22	65	24
DO65817019	19	C	27	22	65	24
DO65817020	20	C	28	22	65	24
DO65817021	21	C	30	22	65	24
DO65817022	22	C	31	23	65	24
DO65817023	23	C	32	23	65	24
DO65817024	24	C	34	23	65	24
DO65817025	25	C	35	23	65	24
DO65817026	26	C	36	23	65	24

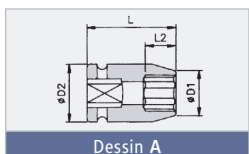

Dessin A

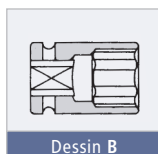

Dessin B

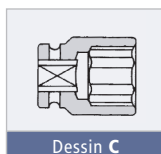

Dessin C

Douilles à choc

□ 3/8"

TAILLE 6-Pans L = 150

Type	C/P mm	Dessin	D1 mm	D2 mm	L mm	L2 mm
------	--------	--------	-------	-------	------	-------

Métriques

DO60715006	6	G	11	19	150	4
DO60715008	8	G	13	19	150	8
DO60715010	10	G	16	19	150	8
DO60715012	12	G	18,5	19	150	9
DO60715013	13	G	20	22	150	9
DO60715014	14	G	21	22	150	9
DO60715015	15	G	22	22	150	11
DO60715016	16	G	24	22	150	11
DO60715017	17	G	25	22	150	11

TAILLE 6-Pans L = 200

Type	C/P mm	Dessin	D1 mm	D2 mm	L mm	L2 mm
------	--------	--------	-------	-------	------	-------

Métriques

DO60716006	6	G	11	19	200	4
DO60716008	8	G	13	19	200	8
DO60716010	10	G	16	19	200	8
DO60716012	12	G	18,5	19	200	9
DO60716013	13	G	20	22	200	9
DO60716014	14	G	21	22	200	9
DO60716015	15	G	22	22	200	11
DO60716016	16	G	24	22	200	11
DO60716017	17	G	25	22	200	11

TAILLE 6-Pans L = 250

Type	C/P mm	Dessin	D1 mm	D2 mm	L mm	L2 mm
------	--------	--------	-------	-------	------	-------

Métriques

DO60717006	6	G	11	19	250	4
DO60717008	8	G	13	19	250	8
DO60717010	10	G	16	19	250	8
DO60717012	12	G	18,5	19	250	9
DO60717013	13	G	20	22	250	9
DO60717014	14	G	21	22	250	9
DO60717015	15	G	22	22	250	11
DO60717016	16	G	24	22	250	11
DO60717017	17	G	25	22	250	11

TAILLE Surface Drive normales

Type	C/P mm	Dessin	D1 mm	D2 mm	L mm	L2 mm
------	--------	--------	-------	-------	------	-------

Métriques

DO63415008	8	A	13,8	19	32	8
DO63415009	9	A	15	19	32	8
DO63415010	10	A	16	19	32	8
DO63415011	11	A	17,5	19	32	9
DO63415012	12	B	19	19	32	9
DO63415013	13	A	20	22	32	9
DO63415014	14	B	22	22	32	9
DO63415015	15	B	22	22	32	11
DO63415016	16	C	24	22	32	11
DO63415017	17	C	25	22	32	11
DO63415018	18	C	26	22	32	11
DO63415019	19	C	28	22	32	11

TAILLE Surface Drive normales

Type	C/P Pouce	Dessin	D1 mm	D2 mm	L mm	L2 mm
------	-----------	--------	-------	-------	------	-------

SAE

DO63410008	1/4"	A	11,5	19	32	4
DO63410010	5/16"	A	13,8	19	32	8
DO63410012	3/8"	A	15,5	19	32	8
DO63410014	7/16"	A	17,5	19	32	9
DO63410016	1/2"	A	20	22	32	9
DO63410018	9/16"	B	22	22	32	11
DO63410020	5/8"	C	24	22	32	11
DO63410022	11/16"	C	26	22	32	11
DO63410024	3/4"	C	28	22	32	11

TAILLE Surface Drive profonde

Type	C/P mm	Dessin	D1 mm	D2 mm	L mm	L2 mm
------	--------	--------	-------	-------	------	-------

Métriques

DO63417008	8	A	13,8	19	80	12
DO63417009	9	A	15	19	80	12
DO63417010	10	A	16	19	80	12
DO63417011	11	A	17,5	19	80	25
DO63417012	12	B	19	19	80	25
DO63417013	13	A	20	22	80	25
DO63417014	14	B	22	22	80	25
DO63417015	15	B	22	22	80	25
DO63417016	16	C	24	22	80	25
DO63417017	17	C	25	22	80	25
DO63417018	18	C	26	22	80	25
DO63417019	19	C	28	22	80	25



1

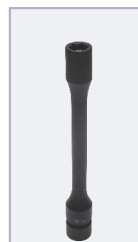

2

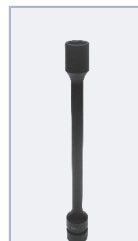

3



4



5

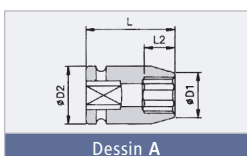

Dessin A

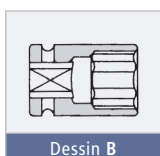

Dessin B

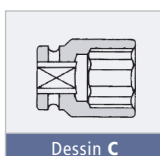

Dessin C



Dessin G

Douilles à choc

□ 3/8"



1

TAILLE

Surface Drive profonde

Type C/P Dessin D1 mm D2 mm L mm L2 mm

SAE

Type	C/P	Dessin	D1 mm	D2 mm	L mm	L2 mm
DO63412010	5/16"	A	13,8	19	80	12
DO63412012	3/8"	A	15,5	19	80	12
DO63412014	7/16"	A	17,5	19	80	25
DO63412016	1/2"	A	20	22	80	25
DO63412018	9/16"	B	22	22	80	25
DO63412020	5/8"	C	24	22	80	25
DO63412022	11/16"	C	26	22	80	25
DO63412024	3/4"	C	28	22	80	25
DO63410024	3/4"	C	28	22	32	11



2

TAILLE

Torx® intérieure

Type C/P Dessin D2 mm L mm L2 mm

Type	C/P	Dessin	D2 mm	L mm	L2 mm
DO64711009	T9	F	19	2,8	50
DO64711010	T10	F	19	2,8	50
DO64711015	T15	F	19	2,8	50
DO64711020	T20	F	19	3,0	50
DO64711025	T25	F	19	3,0	50
DO64711027	T27	F	19	3,8	50
DO64711030	T30	F	19	3,8	50
DO64711040	T40	F	19	4,3	50
DO64711045	T45	F	19	5,0	50
DO64711047	T47	F	19	5,0	50
DO64711050	T50	F	19	5,5	50



3

TAILLE

Torx® extérieure

Type C/P Dessin D1 mm D2 mm L mm L2 mm

Type	C/P	Dessin	D1 mm	D2 mm	L mm	L2 mm
DO63310005	E5	A	9	19	32	4,5
DO63310006	E6	A	10	19	32	5
DO63310007	E7	A	10	19	32	6
DO63310008	E8	A	10,5	19	32	6
DO63310010	E10	A	12,5	19	32	7,5
DO63310011	E11	A	14,5	19	32	8
DO63310012	E12	A	15	19	32	8,5
DO63310014	E14	A	17,5	19	32	10
DO63310016	E16	B	19	19	32	11
DO63310018	E18	B	21	21	34	12,5



4

TAILLE

Torx® Tamper Resistant intérieure

Type C/P Dessin D2 mm L mm L2 mm

Type	C/P	Dessin	D2 mm	L mm	L2 mm
DO64716020	T20	F	19	3,0	50
DO64716025	T25	F	19	3,0	50
DO64716027	T27	F	19	3,8	50
DO64716030	T30	F	19	3,8	50
DO64716040	T40	F	19	4,3	50
DO64716045	T45	F	19	5,0	50
DO64716047	T47	F	19	5,0	50
DO64716050	T50	F	19	5,5	50
DO64716055	T55	F	19	5,5	50

TAILLE

Torx® à paroi mince extérieure

Type C/P Dessin D1 mm D2 mm L mm L2 mm

Type	C/P	Dessin	D1 mm	D2 mm	L mm	L2 mm
DO63315005	E5	A	8	19	32	4,5
DO63315006	E6	A	9	19	32	5
DO63315007	E7	A	9,3	19	32	6
DO63315008	E8	A	10	19	32	6
DO63315010	E10	A	12,3	19	32	7,5
DO63315011	E11	A	13	19	32	8
DO63315012	E12	A	14	19	32	8,5
DO63315014	E14	A	16,5	19	32	10
DO63315016	E16	A	18,4	19	32	11

Prise Goujon

Type Taille D1 mm D2 mm L mm

Type	Taille	D1 mm	D2 mm	L mm
DO69781050	M5x0,8	22	12	50
DO69781053	M6x1,0	22	12,5	50
DO69781059	M8x1,0	22	15	50
DO69781060	M8x1,25	22	14,5	50
DO69781062	M10x1,25	22	18	50
DO69781063	M10x1,5	22	17	50
DO69781066	M12x1,75	22	19	50

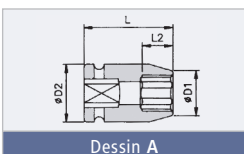
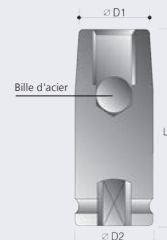

Dessin A

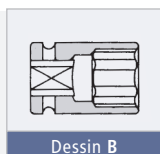

Dessin B

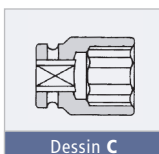

Dessin C

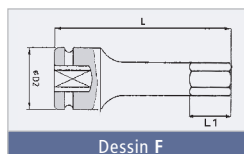

Dessin F

Douilles à choc

□ 3/8"



Douille à paroi mince

TAILLE

6-Pans à paroi mince normales

Type	C/P mm	Dessin	D1 mm	D2 mm	L mm	L2 mm
------	--------	--------	-------	-------	------	-------

Métriques

DO61110006	6	A	10,5	19	30	4
DO61110007	7	A	11,5	19	30	8
DO61110008	8	A	12,5	19	30	8
DO61110009	9	A	14	19	30	8
DO61110010	10	A	15	19	30	8
DO61110011	11	A	17	19	30	9
DO61110012	12	A	17,5	19	30	9
DO61110013	13	B	19	19	30	9
DO61110014	14	B	20	20	30	9

Les douilles à paroi mince ne sont pas couvertes par la garantie Action.

TAILLE

6-Pans à paroi mince profonde

Type	C/P mm	Dessin	D1 mm	D2 mm	L mm	L2 mm
------	--------	--------	-------	-------	------	-------

Métriques

DO61112007	7	A	11,5	19	65	12
DO61112008	8	A	12,5	19	65	12
DO61112009	9	A	14	19	65	12
DO61112010	10	A	15	19	65	25
DO61112011	11	A	17	19	65	25
DO61112012	12	A	17,5	19	65	25
DO61112013	13	B	19	19	65	25
DO61112014	14	B	20	20	65	25
DO61112015	15	A	21	22	65	25
DO61112016	16	C	22,5	22	65	25
DO61112017	17	C	24	22	65	25
DO61112018	18	C	25	22	65	25
DO61112019	19	C	26	22	65	25
DO61112020	20	C	27	22	65	25
DO61112021	21	C	28	22	65	25
DO61112022	22	C	30	23	65	25

Les douilles à paroi mince ne sont pas couvertes par la garantie Action.

TAILLE

6-Pans Cardan normales

Type	C/P mm	Dessin	D1 mm	D2 mm	L mm	L2 mm
------	--------	--------	-------	-------	------	-------

Métriques

DO1038-2-009	9	E	15	24	53	9
DO1038-2-010	10	E	15	24	53	9
DO1038-2-011	11	E	17	24	53	9
DO1038-2-012	12	E	19	24	53	12
DO1038-2-013	13	E	19	24	53	13
DO1038-2-014	14	E	21	24	53	13
DO1038-2-015	15	E	22	24	53	13
DO1038-2-016	16	E	23	24	53	13
DO1038-2-017	17	E	25	24	53	13
DO1038-2-018	18	E	25	24	53	13
DO1038-2-019	19	E	27	24	53	13
DO1038-2-020	20	E	30	24	53	13
DO1038-2-021	21	E	30	24	53	13
DO1038-2-022	22	E	32	24	53	13

TAILLE

6-Pans Cardan profonde

Type	C/P mm	Dessin	D1 mm	D2 mm	L mm	L2 mm
------	--------	--------	-------	-------	------	-------

Métriques

DO1038-4-009	9	E	15	24	78	20
DO1038-4-010	10	E	15	24	78	20
DO1038-4-011	11	E	17	24	80	20
DO1038-4-012	12	E	19	24	80	20
DO1038-4-013	13	E	19	24	80	20
DO1038-4-014	14	E	21	24	80	20
DO1038-4-015	15	E	22	24	80	20
DO1038-4-016	16	E	23	24	80	20
DO1038-4-017	17	E	25	24	80	20
DO1038-4-018	18	E	25	24	80	20
DO1038-4-019	19	E	27	24	80	25
DO1038-4-020	20	E	30	24	80	25
DO1038-4-021	21	E	30	24	80	25
DO1038-4-022	22	E	32	24	80	25

Les douilles à cardan sont sécurisées par une bague.



1



2



3



4

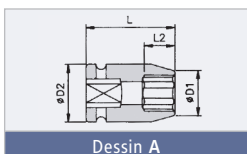

Dessin A

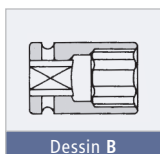

Dessin B

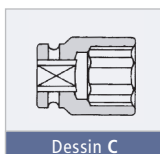

Dessin C

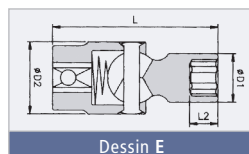

Dessin E

Douilles à choc

□ 3/8"



Douille à cardan



1

TAILLE

Empreinte 6-Pans (Inbus) 1

Type	C/P mm	Dessin	D2 mm	L1 mm	L mm	-
------	--------	--------	-------	-------	------	---

Métriques

DO696203A	3	F	19	16	50	-
DO696204A	4	F	19	16	50	-
DO696205A	5	F	19	16	50	-
DO696206A	6	F	19	16	50	-
DO696207A	7	F	19	16	50	-
DO696208A	8	F	19	16	50	-
DO696209A	9	F	19	16	50	-
DO696210A	10	F	19	16	50	-
DO696211A	11	F	19	16	50	-
DO696212A	12	F	19	16	50	-
DO696213A	13	F	19	16	50	-
DO696214A	14	F	19	16	50	-
DO696215A	15	F	19	16	50	-
DO696216A	16	F	19	16	50	-



2

TAILLE

Carré triple 2

Type	C/P	Dessin	D2 mm	L mm	L1 mm	-
------	-----	--------	-------	------	-------	---

Métriques

DO65216005	M5	F	19	50	7	-
DO65216006	M6	F	19	50	7	-
DO65216008	M8	F	19	50	9	-
DO65216010	M10	F	19	50	9	-
DO65216012	M12	F	19	50	11	-
DO65216014	M14	F	19	50	11	-
DO65216016	M16	F	19	50	13	-



3



4

TAILLE

Carré triple longues 3

Type	C/P	Dessin	D2 mm	L mm	L1 mm	-
------	-----	--------	-------	------	-------	---

Métriques

DO65217005	M5	F	19	100	7	-
DO65217006	M6	F	19	100	7	-
DO65217008	M8	F	19	100	9	-
DO65217010	M10	F	19	100	9	-
DO65217012	M12	F	19	100	11	-
DO65217014	M14	F	19	100	11	-
DO65217016	M16	F	19	100	13	-



5



6

Joint torique clavette

DO1038-0-000

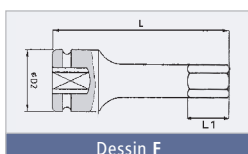
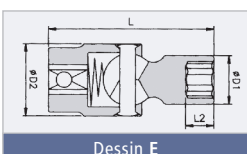

TAILLE

Cardan empreinte 6-Pans 4

Type	C/P mm	Dessin	D2 mm	L mm	L2 mm	-
------	--------	--------	-------	------	-------	---

Métriques

DO65110005	5	E	24	60	11	-
DO65110006	6	E	24	60	11	-
DO65110007	7	E	24	60	15	-
DO65110008	8	E	24	60	15	-
DO65110009	9	E	24	60	15	-
DO65110010	10	E	24	60	15	-
DO65110011	11	E	24	60	15	-
DO65110012	12	E	24	60	15	-
DO65110013	13	E	24	60	15	-
DO65110014	14	E	24	60	15	-
DO65110015	15	E	24	60	15	-
DO65110016	16	E	24	60	15	-

TAILLE

Cardan Torx® intérieure 5

Type	C/P	Dessin	D2 mm	L mm	-	-
------	-----	--------	-------	------	---	---

DO64910020	T20	E	24	60	-	-
DO64910025	T25	E	24	60	-	-
DO64910027	T27	E	24	60	-	-
DO64910030	T30	E	24	60	-	-
DO64910040	T40	E	24	60	-	-
DO64910045	T45	E	24	60	-	-
DO64910047	T47	E	24	60	-	-
DO64910050	T50	E	24	60	-	-
DO64910055	T55	E	24	60	-	-

TAILLE

Cardan Torx® extérieure 6

Type	C/P	Dessin	D2 mm	L mm	L2 mm	-
------	-----	--------	-------	------	-------	---

DO68710005	E5	E	24	50	4,5	-
DO68710006	E6	E	24	50	5	-
DO68710007	E7	E	24	50	6	-
DO68710008	E8	E	24	50	6	-
DO68710010	E10	E	24	50	7,5	-
DO68710012	E12	E	24	50	8,5	-
DO68710014	E14	E	24	50	10	-
DO68710016	E16	E	24	50	11	-

Douilles à choc

3/8"

TAILLE							1
Profil Ribe							

Type	C/P mm	Dessin	D2 mm	L mm	L1 mm	-
------	--------	--------	-------	------	-------	---

Métriques

DO65315005	M5	A	19	50	4,5	-
DO65315006	M6	A	19	50	5	-
DO65315007	M7	A	19	50	6,5	-
DO65315008	M8	A	19	50	7,5	-
DO65315010	M10	A	19	50	9	-
DO65315012	M12	A	19	50	10	-
DO65315014	M14	A	19	50	12	-
DO65315016	M16	A	19	50	14	-

TAILLE							2
Douille porte-taroud							

Type	A mm	Dessin	Ø D1 mm	Ø D2 mm	Ø d mm	L mm
------	------	--------	---------	---------	--------	------

Métriques

DO6321B001	3,4	D	19	19	4,5	38
DO6321B002	4,9	D	19	19	6,0	38
DO6321B003	5,5	D	19	19	7,0	40
DO6321B004	6,2	D	19	19	8,0	40
DO6321B005	7,0	D	19	19	9,0	43
DO6321B006	8,0	D	19	19	10,0	45
DO6321B007	9,0	D	19	19	11,0	45
DO6321B008	9,0	D	22	22	12,0	45
DO6321B009	11,0	D	22	22	14,0	45

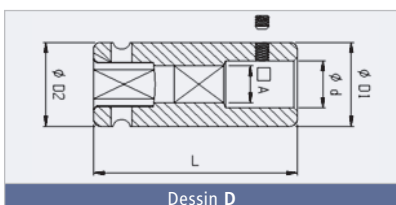
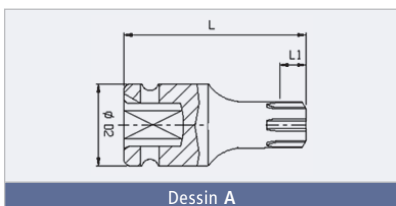

1/2"

TAILLE							3
4-Pans							

Type	C/P mm	Dessin	D1 mm	D2 mm	L mm	L2 mm
------	--------	--------	-------	-------	------	-------

Métriques

DO63125008	8	A	19	25	40	9
DO63125010	10	A	21,5	25	40	10
DO63125011	11	A	23	25	40	11
DO63125012	12	A	24	25	40	12
DO63125013	13	A	26	30	40	12
DO63125014	14	A	27,5	30	40	20
DO63125016	16	B	30	30	40	20
DO63125017	17	C	32	30	40	20
DO63125019	19	C	36	30	45	20
DO63125021	21	C	40	30	45	20
DO63125022	22	C	42	30	45	20
DO63125024	24	C	44	30	50	22
DO63125030	30	C	53	30	50	22
DO63125032	32	C	56	30	50	22

TAILLE							4
Douille octogonal							

Type	C/P mm	Dessin	D1 mm	D2 mm	L mm	L2 mm
------	--------	--------	-------	-------	------	-------

Métriques

DO2012-8-017	17	B	30	30	38	11
DO2012-8-019	19	B	34	34	40	13
DO2012-8-022	22	B	38	38	40	15
DO2012-8-024	24	B	42	38	45	18
DO2012-8-027	27	B	46,5	46,5	50	19
DO2012-8-028	28	B	49	49	50	19

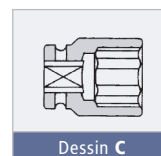
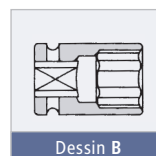
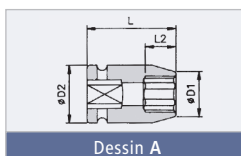

1



2



3

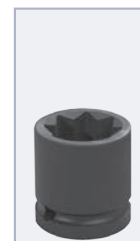

4

Douilles à choc

1/2"



1



2



3

TAILLE 1

6-Pans normales

Type	C/P mm	Dessin	D1 mm	D2 mm	L mm	L2 mm
------	--------	--------	-------	-------	------	-------

Métriques

DO2012-0-008	8	A	14,5	25	38	9
DO2012-0-009	9	A	16	25	38	12
DO2012-0-010	10	A	17	25	38	12
DO2012-0-011	11	A	19	25	38	12
DO2012-0-012	12	A	20	24	38	12
DO2012-0-013	13	A	21	25	38	12
DO2012-0-014	14	A	22	25	38	12
DO2012-0-015	15	A	24	30	38	12
DO2012-0-016	16	A	25	30	38	12
DO2012-0-017	17	A	26	30	38	13
DO2012-0-018	18	A	27,5	30	38	13
DO2012-0-019	19	A	29	30	38	13
DO2012-0-020	20	B	30	30	38	13
DO2012-0-021	21	B	32	30	38	13
DO2012-0-022	22	C	32	30	38	13
DO2012-0-023	23	C	32,5	30	38	13
DO2012-0-024	24	C	35	30	45	20
DO2012-0-025	25	C	36	30	45	20
DO2012-0-026	26	C	37,5	30	45	22
DO2012-0-027	27	C	39	30	50	22
DO2012-0-028	28	C	40	30	50	22
DO2012-0-029	29	C	41	30	50	22
DO2012-0-030	30	C	42,5	30	50	22
DO2012-0-032	32	C	44	30	50	28
DO2012-0-034	34	C	45	30	50	28
DO2012-0-036	36	C	48	30	50	28
DO2012-0-038	38	C	53	38	50	24
DO2012-0-041	41	C	58	44	60	27
DO2012-0-046	46	C	65	44	70	30

TAILLE 1

6-Pans normales

Type	C/P Pouce	Dessin	D1 mm	D2 mm	L mm	L2 mm
------	-----------	--------	-------	-------	------	-------

Pouce

DO2012-0-3/8	3/8"	A	16	22	38	12
DO2012-0-7/16	7/16"	A	18	22	38	12
DO2012-0-1/2	1/2"	A	20	22	38	12
DO2012-0-9/16	9/16"	A	22	24	38	12
DO2012-0-5/8	5/8"	B	25	25	38	12
DO2012-0-11/16	11/16"	B	26	26	38	13
DO2012-0-3/4	3/4"	B	28	28	38	13
DO2012-0-13/16	13/16"	B	30	30	38	13
DO2012-0-7/8	7/8"	B	32	32	38	13
DO2012-0-15/16	15/16"	B	34	34	38	13
DO2012-0-1	1"	B	36	36	38	14
DO2012-0-1 1/16	1 1/16"	B	38	38	40	16
DO2012-0-1 1/8	1 1/8"	B	40	38	40	16
DO2012-0-1 3/16	1 3/16"	C	42	38	40	16
DO2012-0-1 1/4	1 1/4"	C	44	38	40	18

TAILLE 2

6-Pans normales magnétique

Type	C/P mm	Dessin	D1 mm	D2 mm	L mm	L2 mm
------	--------	--------	-------	-------	------	-------

Métriques

DO6052P008	8	A	15	25	38	3
DO6052P009	9	A	16	25	38	4
DO6052P010	10	A	17,5	25	38	4
DO6052P011	11	A	18,5	25	38	5
DO6052P012	12	A	20	25	38	5
DO6052P013	13	A	21	25	38	5
DO6052P014	14	A	22,5	25	38	6
DO6052P015	15	A	23,7	30	38	6
DO6052P016	16	A	25	30	38	6
DO6052P017	17	A	26,5	30	38	6
DO6052P018	18	A	27,5	30	38	7
DO6052P019	19	A	29	30	38	7
DO6052P020	20	B	30	30	38	7
DO6052P021	21	C	31	30	38	8
DO6052P022	22	C	32,5	30	38	8
DO6052P024	24	C	35	30	45	10

TAILLE 3

6-Pans profonde

Type	C/P mm	Dessin	D1 mm	D2 mm	L mm	L2 mm
------	--------	--------	-------	-------	------	-------

Métriques

DO2012-1-008	8	A	14,5	25	78	13
DO2012-1-009	9	A	16	25	78	14
DO2012-1-010	10	A	17	25	78	14
DO2012-1-011	11	A	18	25	78	14
DO2012-1-012	12	A	19,5	25	78	14
DO2012-1-013	13	A	21	25	78	14
DO2012-1-014	14	A	22	25	78	17
DO2012-1-015	15	A	23,5	30	78	17
DO2012-1-016	16	A	23,5	30	78	17
DO2012-1-017	17	A	26	30	78	17
DO2012-1-018	18	A	26	30	78	17
DO2012-1-019	19	A	28	30	78	19
DO2012-1-020	20	B	30,5	30	78	19
DO2012-1-021	21	B	31	30	78	24
DO2012-1-022	22	C	32,5	30	78	24
DO2012-1-023	23	C	32,5	30	78	24
DO2012-1-024	24	C	35	30	78	24
DO2012-1-025	25	C	36	30	78	24
DO2012-1-026	26	C	37,5	30	78	24

Suite page suivante ►

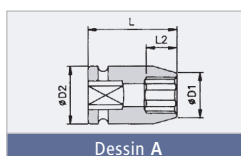

Dessin A

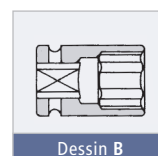

Dessin B

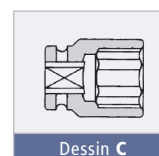

Dessin C

Douilles à choc

□ 1/2"



Douille à tête 6 pans

TAILLE

6-Pans profonde (suite)

Type	C/P mm	Dessin	D1 mm	D2 mm	L mm	L2 mm
------	--------	--------	-------	-------	------	-------

Métriques

DO2012-1-027	27	C	38	30	78	54
DO2012-1-028	28	C	40	30	78	54
DO2012-1-029	29	C	40	30	78	54
DO2012-1-030	30	C	42	30	78	54
DO2012-1-031	31	C	43	30	78	54
DO2012-1-032	32	C	45	30	78	54
DO2012-1-033	33	C	45	30	78	22
DO2012-1-034	34	C	45	30	78	22
DO2012-1-035	35	C	47	30	78	22
DO2012-1-036	36	C	49	30	78	24
DO2012-1-041	41	C	48	44	93	58
DO2012-1-046	46	C	65	44	93	58

TAILLE

6-Pans profonde

Type	C/P Pouce	Dessin	D1 mm	D2 mm	L mm	L2 mm
------	-----------	--------	-------	-------	------	-------

SAE

DO2012-1-7/16	7/16"	A	18	22	78	14
DO2012-1-1/2	1/2"	A	20	22	78	14
DO2012-1-9/16	9/16"	A	22	24	78	17
DO2012-1-5/8	5/8"	B	26	26	78	17
DO2012-1-11/16	11/16"	B	26	26	78	17
DO2012-1-3/4	3/4"	B	28	28	78	19
DO2012-1-13/16	13/16"	B	30	30	78	24
DO2012-1-7/8	7/8"	B	32	32	78	24

TAILLE

6-Pans profonde magnétique

Type	C/P mm	Dessin	D1 mm	D2 mm	L mm	L2 mm
------	--------	--------	-------	-------	------	-------

Métriques

DO6052R008	8	A	15	25	78	3
DO6052R009	9	A	16	25	78	4
DO6052R010	10	A	17,5	25	78	4
DO6052R011	11	A	18,5	25	78	5
DO6052R012	12	A	20	25	78	5
DO6052R013	13	A	21	25	78	5
DO6052R014	14	A	22,5	25	78	6
DO6052R015	15	A	23,7	30	78	6
DO6052R016	16	A	25	30	78	6
DO6052R017	17	A	26,5	30	78	6
DO6052R018	18	A	27,5	30	78	7
DO6052R019	19	A	29	30	78	7
DO6052R020	20	B	30	30	78	7
DO6052R021	21	C	31	30	78	8
DO6052R022	22	C	32,5	30	78	8
DO6052R024	24	C	35	30	78	10

TAILLE

6-Pans paroi mince normales

Type	C/P mm	Dessin	D1 mm	D2 mm	L mm	L2 mm
------	--------	--------	-------	-------	------	-------

Métriques

DO61120008	8	A	13	25	38	6
DO61120009	9	A	14,5	25	38	6
DO61120010	10	A	15,5	25	38	7
DO61120011	11	A	16,7	25	38	8
DO61120012	12	A	18	25	38	9
DO61120013	13	A	19,2	25	38	9
DO61120014	14	A	21	25	38	11
DO61120015	15	A	21,7	30	38	11
DO61120016	16	A	23	30	38	11
DO61120017	17	B	24	30	38	11
DO61120018	18	B	25	30	38	13
DO61120019	19	B	26	30	38	13
DO61120020	20	B	27,5	30	38	13
DO61120021	21	B	28	30	38	15
DO61120022	22	B	29,5	30	38	15
DO61120023	23	C	30,5	30	38	15
DO61120024	24	C	32	30	45	18
DO61120025	25	C	34	30	45	18
DO61120026	26	C	35	30	50	18
DO61120027	27	C	36	30	50	19
DO61120028	28	C	37	30	50	20
DO61120029	29	C	38	30	50	20
DO61120030	30	C	40	30	50	21
DO61120031	31	C	41	30	50	21
DO61120032	32	C	42	30	50	22

TAILLE

6-Pans paroi mince profonde

Type	C/P mm	Dessin	D1 mm	D2 mm	L mm	L2 mm
------	--------	--------	-------	-------	------	-------

Métriques

DO61122008	8	A	14	22	78	13
DO61122009	9	A	14,5	22	78	14
DO61122010	10	A	15,5	22	78	14
DO61122011	11	A	16,7	22	78	14
DO61122012	12	A	18	22	78	14
DO61122013	13	A	19,2	24	78	14
DO61122014	14	A	21	24	78	17
DO61122015	15	A	21,7	24	78	17
DO61122016	16	A	23	24	78	17
DO61122017	17	B	24	24	78	17



1



2



3



4

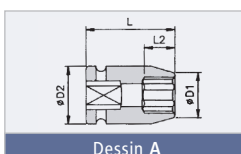

Dessin A

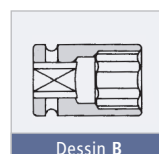

Dessin B

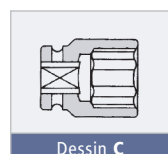

Dessin C

Douilles à choc

1/2"



1



2



3



4



5

TAILLE

6-Pans paroi mince profonde

Type	C/P mm	Dessin	D1 mm	D2 mm	L mm	L2 mm
------	--------	--------	-------	-------	------	-------

Métriques

DO61122018	18	B	25	25	78	17
DO61122019	19	B	26	26	78	19
DO61122020	20	B	27,5	27,5	78	19
DO61122021	21	B	28	28	78	24
DO61122022	22	B	29,5	29,5	78	24
DO61122023	23	B	30,5	30,5	78	24
DO61122024	24	B	32	32	78	24
DO61122025	25	B	33	33	78	24
DO61122026	26	B	35	35	78	24
DO61122027	27	B	36	36	78	24
DO61122028	28	B	37,5	37,5	78	24
DO61122029	29	C	38,5	38	78	54
DO61122030	30	C	40	38	78	54
DO61122031	31	C	41	38	78	54
DO61122032	32	C	42	38	78	54

Les douilles à paroi mince ne sont pas couvertes par la garantie Action.

TAILLE

6-Pans paroi mince profonde avec butée et manchon plastique

Type	C/P mm	Dessin	D1 mm	D2 mm	D3 mm	L mm	L2 mm
------	--------	--------	-------	-------	-------	------	-------

Métriques

DO61126015 (blanc)	15	H	22	30	25	85	13
DO61126017 (bleu)	17	H	24	30	27	85	14
DO61126019 (jaune)	19	H	26	30	29	85	15
DO61126021 (rouge)	21	H	28	30	31	85	17
DO61126022 (vert)	22	H	29,5	30	32,5	85	18
DO6112J017 (bleu)	17	H	24	30	27	130	14
DO6112J019 (jaune)	19	H	26	30	29	130	15
DO6112J021 (rouge)	21	H	28	30	31	130	17
DO6112J022 (vert)	22	H	29,5	30	32,5	130	18

Les douilles à paroi mince ne sont pas couvertes par la garantie Action.

TAILLE

6-Pans L = 150

Type	C/P mm	Dessin	D1 mm	D2 mm	L mm	L2 mm
------	--------	--------	-------	-------	------	-------

Métriques

DO60725008	8	G	15	25	150	10
DO60725010	10	G	17	25	150	12
DO60725012	12	G	19,5	25	150	12
DO60725013	13	G	20,5	25	150	12
DO60725014	14	G	22	25	150	12
DO60725015	15	G	23	25	150	12
DO60725017	17	G	25,5	25	150	13
DO60725019	19	G	28	25	150	13
DO60725020	20	G	30	25	150	13
DO60725021	21	G	30	25	150	13

TAILLE

6-Pans L = 200

Type	C/P mm	Dessin	D1 mm	D2 mm	L mm	L2 mm
------	--------	--------	-------	-------	------	-------

Métriques

DO60726008	8	G	15	25	200	10
DO60726010	10	G	17	25	200	12
DO60726012	12	G	19,5	25	200	12
DO60726013	13	G	20,5	25	200	12
DO60726014	14	G	22	25	200	12
DO60726015	15	G	23	25	200	12
DO60726017	17	G	25,5	25	200	13
DO60726019	19	G	28	25	200	13
DO60726020	20	G	30	25	200	13
DO60726021	21	G	30	25	200	13

TAILLE

6-Pans L = 250

Type	C/P mm	Dessin	D1 mm	D2 mm	L mm	L2 mm
------	--------	--------	-------	-------	------	-------

Métriques

DO60727008	8	G	15	25	250	10
DO60727010	10	G	17	25	250	12
DO60727012	12	G	19,5	25	250	12
DO60727013	13	G	20,5	25	250	12
DO60727014	14	G	22	25	250	12
DO60727015	15	G	23	25	250	12
DO60727017	17	G	25,5	25	250	13
DO60727019	19	G	28	25	250	13
DO60727020	20	G	30	25	250	13
DO60727021	21	G	30	25	250	13

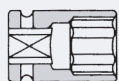

Dessin B

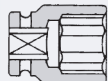

Dessin C

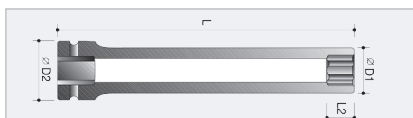

Dessin G

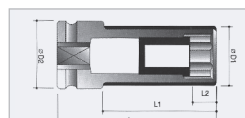

Dessin H

Douilles à choc

1/2"

TAILLE						
12-Pans normales						1
Type	C/P mm	Dessin	D1 mm	D2 mm	L mm	L2 mm
Métriques						
DO63825006	6	A	13	25	38	5
DO63825008	8	A	14	25	38	6
DO63825009	9	A	16	25	38	6
DO63825010	10	A	17,5	25	38	7
DO63825011	11	A	19	25	38	8
DO63825012	12	A	20	25	38	9
DO63825013	13	A	21	25	38	9
DO63825014	14	A	22,5	25	38	11
DO63825015	15	A	23,5	30	38	11
DO63825016	16	A	25	30	38	11
DO63825017	17	A	26,5	30	40	11
DO63825018	18	A	27,5	30	40	13
DO63825019	19	A	29	30	40	13
DO63825020	20	B	30	30	40	13
DO63825021	21	C	31	30	40	15
DO63825022	22	C	32,5	30	40	15
DO63825023	23	C	34	30	40	15
DO63825024	24	C	35	30	45	18
DO63825025	25	C	36	30	45	18
DO63825026	26	C	38	30	50	18
DO63825027	27	C	39	30	50	19
DO63825028	28	C	40	30	50	19
DO63825029	29	C	41	30	50	19
DO63825030	30	C	42,5	30	50	21
DO63825032	32	C	44	30	50	22
DO63825033	33	C	46,5	30	50	22
DO63825036	36	C	50,5	30	50	24

TAILLE						
12-Pans profonde						2
Type	C/P mm	Dessin	D1 mm	D2 mm	L mm	L2 mm
Métriques						
DO65827006	6	A	13	25	83	5
DO65827007	7	A	14	25	83	5
DO65827008	8	A	15	25	83	6
DO65827009	9	A	16	25	83	6
DO65827010	10	A	17,5	25	83	7
DO65827011	11	A	19	25	83	8
DO65827012	12	A	20	25	83	9
DO65827013	13	A	21	25	83	9
DO65827014	14	A	22,5	25	83	11
DO65827015	15	A	23,5	30	83	11
DO65827016	16	A	25	30	83	11
DO65827017	17	A	26,5	30	83	11
DO65827018	18	A	27,5	30	83	13
DO65827019	19	A	29	30	83	13
DO65827020	20	B	30	30	83	13
DO65827021	21	C	31	30	83	15
DO65827022	22	C	32,5	30	90	15
DO65827023	23	C	34	30	90	15
DO65827024	24	C	35	30	90	18
DO65827025	25	C	36	30	90	18
DO65827026	26	C	38	30	90	18
DO65827027	27	C	39	30	90	19
DO65827028	28	C	40	30	90	19
DO65827029	29	C	41	30	90	19
DO65827030	30	C	42,5	30	90	21
DO65827031	31	C	44	30	90	21
DO65827032	32	C	45	30	90	22
DO65827033	33	C	46,5	30	90	22
DO65827034	34	C	48	30	90	22
DO65827035	35	C	49,5	30	90	22
DO65827036	36	C	50,5	30	90	24
DO65827038	38	C	53	38	90	24
DO65827039	39	C	54,5	44	93	24
DO65827040	40	C	56	44	93	58
DO65827041	41	C	58	44	93	58
DO65827042	42	C	60	44	93	58
DO65827043	43	C	61	44	93	58
DO65827044	44	C	63	44	93	58
DO65827045	45	C	64	44	93	58
DO65827046	46	C	65	44	93	58
DO65827047	47	C	66,5	44	93	58
DO65827048	48	C	68	44	93	58
DO65827049	49	C	69	44	93	58
DO65827050	50	C	70	52	93	58
DO65827051	51	C	71	52	93	58
DO65827052	52	C	72,5	52	93	58
DO65827053	53	C	74	52	93	58
DO65827054	54	C	75	52	93	58
DO65827055	55	C	76	52	93	58
DO65827056	56	C	77	52	93	58
DO65827057	57	C	78	52	93	58
DO65827058	58	C	79	52	93	58



1



2

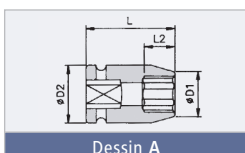

Dessin A

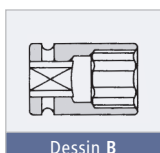

Dessin B

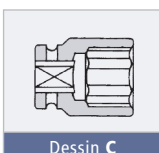

Dessin C

Douilles à choc

□ 1/2"



1



2



3



4

TAILLE

Surface Drive normales



1

Type	C/P mm	Dessin	D1 mm	D2 mm	L mm	L2 mm
------	--------	--------	-------	-------	------	-------

Métriques

DO63425010	10	A	17,5	25	38	12
DO63425011	11	A	18,7	25	38	12
DO63425012	12	A	20	25	38	12
DO63425013	13	A	21	25	38	12
DO63425014	14	A	22,5	25	38	12
DO63425015	15	A	23,7	30	38	12
DO63425016	16	A	25	30	38	12
DO63425017	17	A	26	30	38	13
DO63425018	18	A	27,5	30	38	13
DO63425019	19	A	28,7	30	38	13
DO63425020	20	B	30	30	38	13
DO63425021	21	B	30	30	38	13
DO63425022	22	C	32	30	38	13
DO63425023	23	C	32	30	38	13
DO63425024	24	C	35	30	45	20
DO63425026	26	C	38	30	50	22
DO63425027	27	C	38,7	30	50	22
DO63425029	29	C	40	30	50	22
DO63425030	30	C	42	30	50	22
DO63425032	32	C	44	30	50	28

TAILLE

Surface Drive profonde



2

Type	C/P mm	Dessin	D1 mm	D2 mm	L mm	L2 mm
------	--------	--------	-------	-------	------	-------

Métriques

DO63427010	10	A	17,5	25	83	14
DO63427011	11	A	18,7	25	83	14
DO63427012	12	A	20	25	83	14
DO63427013	13	A	21	25	83	14
DO63427014	14	A	22,5	25	83	17
DO63427015	15	A	23,7	30	83	17
DO63427016	16	A	25	30	83	17
DO63427017	17	A	26	30	83	17
DO63427018	18	A	27,5	30	83	17
DO63427019	19	A	28,7	30	83	19
DO63427020	20	B	30	30	83	19
DO63427021	21	B	30	30	83	24
DO63427022	22	C	32	30	90	24
DO63427023	23	C	32	30	90	24
DO63427024	24	C	35	30	90	24
DO63427026	26	C	38	30	90	24
DO63427027	27	C	38,7	30	90	24
DO63427029	29	C	40	30	90	24
DO63427030	30	C	42	30	90	24
DO63427032	32	C	44	30	90	24

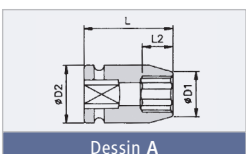

Dessin A

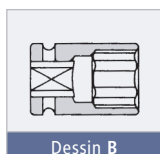

Dessin B

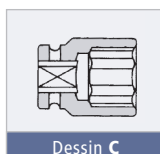

Dessin C

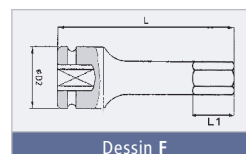

Dessin F

TAILLE

Torx® intérieure



3

Type	C/P	Dessin	D2 mm	L1 mm	L mm	-
------	-----	--------	-------	-------	------	---

DO64721020	T20	F	25	2,8	55	-
DO64721025	T25	F	25	3,0	55	-
DO64721027	T27	F	25	3,0	55	-
DO64721030	T30	F	25	3,8	55	-
DO64721040	T40	F	25	3,8	55	-
DO64721045	T45	F	25	4,3	55	-
DO64721047	T47	F	25	5,0	55	-
DO64721050	T50	F	25	5,0	55	-
DO64721055	T55	F	25	5,5	55	-
DO64721060	T60	F	25	8,0	55	-
DO64721070	T70	F	25	9,4	55	-

TAILLE

Torx® extérieure longues



4

Type	C/P	Dessin	D2 mm	L1 mm	L mm	-
------	-----	--------	-------	-------	------	---

DO64722020	T20	F	25	2,8	75	-
DO64722025	T25	F	25	3,0	75	-
DO64722027	T27	F	25	3,0	75	-
DO64722030	T30	F	25	3,8	75	-
DO64722040	T40	F	25	3,8	75	-
DO64722045	T45	F	25	4,3	75	-
DO64722047	T47	F	25	5,0	75	-
DO64722050	T50	F	25	5,0	75	-
DO64722055	T55	F	25	5,5	75	-
DO64722060	T60	F	25	8,0	75	-
DO64722070	T70	F	25	9,4	75	-

Douilles à choc

□ 1/2"



Douille à tête 6 pans

TAILLE							1
Torx® Tamper Resistant intérieure							
Type	C/P	Dessin	D2 mm	L1 mm	L mm	-	
DO64726020	T20	F	25	2,8	55	-	
DO64726025	T25	F	25	3,0	55	-	
DO64726027	T27	F	25	3,0	55	-	
DO64726030	T30	F	25	3,8	55	-	
DO64726040	T40	F	25	3,8	55	-	
DO64726045	T45	F	25	4,3	55	-	
DO64726047	T47	F	25	5,0	55	-	
DO64726050	T50	F	25	5,0	55	-	
DO64726055	T55	F	25	5,5	55	-	
DO64726060	T60	F	25	8,0	55	-	
DO64726070	T70	F	25	9,4	55	-	

TAILLE							2
Torx® Tamper Resistant intérieure longues							
Type	C/P	Dessin	D2 mm	L1 mm	L mm	-	
DO64727020	T20	F	25	2,8	75	-	
DO64727025	T25	F	25	3,0	75	-	
DO64727027	T27	F	25	3,0	75	-	
DO64727030	T30	F	25	3,8	75	-	
DO64727040	T40	F	25	3,8	75	-	
DO64727045	T45	F	25	4,3	75	-	
DO64727047	T47	F	25	5,0	75	-	
DO64727050	T50	F	25	5,0	75	-	
DO64727055	T55	F	25	5,5	75	-	
DO64727060	T60	F	25	8,0	75	-	
DO64727070	T70	F	25	9,4	75	-	

TAILLE							3
Torx® external							
Type	C/P	Dessin	D1 mm	D2 mm	L mm	L2 mm	
DO63320010	E10	A	15	25	38	7,5	
DO63320011	E11	A	15,5	25	38	8	
DO63320012	E12	A	16	25	38	8,5	
DO63320014	E14	A	18,5	25	38	10	
DO63320016	E16	A	20	25	38	11	
DO63320018	E18	A	22	25	38	12	
DO63320020	E20	A	25	30	38	13,5	
DO63320022	E22	A	26,5	30	45	18	
DO63320024	E24	A	28,5	30	45	18	

TAILLE							4
Torx® paroi mince extérieure							
Type	C/P	Dessin	D1 mm	D2 mm	L mm	L2 mm	
DO63325010	E10	A	13	25	38	7,5	
DO63325011	E11	A	14	25	38	8	
DO63325012	E12	A	15	25	38	8,5	
DO63325014	E14	A	17	25	38	10	
DO63325016	E16	A	18,5	25	38	11	
DO63325018	E18	A	20,5	25	38	12	
DO63325020	E20	A	22,5	30	38	13,5	
DO63325022	E22	A	24,5	30	45	18	
DO63325024	E24	A	26,5	30	45	18	

TAILLE							5
Torx® extérieure magnétique							
Type	C/P	Dessin	D1 mm	D2 mm	L mm	L2 mm	
DO6332N010	E10	D	14,5	25	38	5	
DO6332N011	E11	D	15	25	38	5	
DO6332N012	E12	D	16	25	38	6	
DO6332N014	E14	D	18	25	38	8	
DO6332N016	E16	D	20	25	38	9	
DO6332N018	E18	D	22	25	38	9	
DO6332N020	E20	D	25	30	38	10	
DO6332N022	E22	D	27	30	45	10	
DO6332N024	E24	D	29	30	45	11	

Les douilles à paroi mince ne sont pas couvertes par la garantie Action.
Torx® est une marque commerciale de Textron.



1



2



3



4



5

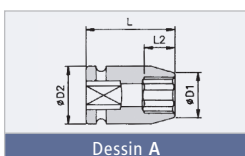

Dessin A

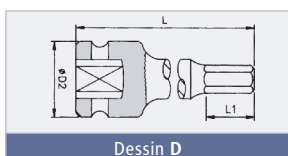

Dessin D

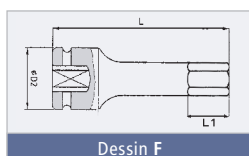

Dessin F

Douilles à choc

□ 1/2"



1



2



3



4

TAILLE

6-Pans Cardan normales



1

Type	C/P mm	Dessin	D1 mm	D2 mm	L mm	L2 mm
------	--------	--------	-------	-------	------	-------

Métriques

DO2012-2-010	10	E	15	28	65	14
DO2012-2-011	11	E	17	28	65	14
DO2012-2-012	12	E	19	28	65	14
DO2012-2-013	13	E	20	28	65	14
DO2012-2-014	14	E	22	28	65	14
DO2012-2-015	15	E	23	28	65	14
DO2012-2-016	16	E	23	28	65	14
DO2012-2-017	17	E	26	32	65	14
DO2012-2-018	18	E	26	32	65	14
DO2012-2-019	19	E	28	32	65	14
DO2012-2-020	20	E	30	32	65	14
DO2012-2-021	21	E	30	32	65	14
DO2012-2-022	22	E	32	32	65	14
DO2012-2-023	23	E	32	32	65	14
DO2012-2-024	24	E	34	32	65	14

TAILLE

6-Pans Cardan profonde



2

Type	C/P mm	Dessin	D1 mm	D2 mm	L mm	L2 mm
------	--------	--------	-------	-------	------	-------

Métriques

DO2012-4-010	10	E	15	28	90	14
DO2012-4-011	11	E	17	28	90	20
DO2012-4-012	12	E	19	28	90	20
DO2012-4-013	13	E	20	28	90	20
DO2012-4-014	14	E	22	28	90	20
DO2012-4-015	15	E	23	28	90	20
DO2012-4-016	16	E	23	28	90	20
DO2012-4-017	17	E	26	32	90	20
DO2012-4-018	18	E	26	32	90	20
DO2012-4-019	19	E	28	32	90	25
DO2012-4-020	20	E	30	32	90	25
DO2012-4-021	21	E	30	32	90	25
DO2012-4-022	22	E	32	32	90	25
DO2012-4-023	23	E	32	32	90	25
DO2012-4-024	24	E	34	32	90	25

TAILLE

Cardan Torx® intérieure



3

Type	C/P	Dessin	D2 mm	L mm	L1 mm	-
------	-----	--------	-------	------	-------	---

DO64921025	T25	G	28	70	3	-
DO64921027	T27	G	28	70	3	-
DO64921030	T30	G	28	70	3,8	-
DO64921040	T40	G	28	70	3,8	-
DO64921045	T45	G	28	70	4,3	-
DO64921047	T47	G	28	70	5	-
DO64921050	T50	G	28	70	5	-
DO64921055	T55	G	28	70	5,5	-
DO64921060	T60	G	28	70	8	-

TAILLE

Cardan Torx® extérieure



4

Type	C/P	Dessin	D1 mm	D2 mm	L mm	L2 mm
------	-----	--------	-------	-------	------	-------

DO68720010	E10	E	13	28	65	7,5
DO68720011	E11	E	14	28	65	8,0
DO68720012	E12	E	15	28	65	8,5
DO68720014	E14	E	17	28	65	10
DO68720016	E16	E	18,5	28	65	11
DO68720018	E18	E	20,5	28	65	12
DO68720020	E20	E	22,5	32	70	13,5
DO68720022	E22	E	24,5	32	70	15
DO68720024	E24	E	26,5	32	70	17

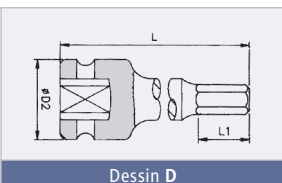

Dessin D

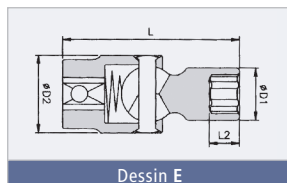

Dessin E

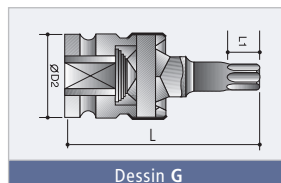

Dessin G

Douilles à choc

□ 1/2"



Douille à empreinte 6 pans

TAILLE

Empreinte 6-Pans (Inbus) 1

Type	C/P mm	Dessin	D2 mm	L mm	L1 mm	-
------	--------	--------	-------	------	-------	---

Métriques

DO696304A	4	D	25	75	11	-
DO696305A	5	D	25	75	15	-
DO696306A	6	D	25	75	15	-
DO696307A	7	D	25	75	15	-
DO696308A	8	D	25	75	16	-
DO696309A	9	D	25	75	16	-
DO696310A	10	D	25	75	16	-
DO696311A	11	D	25	75	16	-
DO696312A	12	D	25	75	16	-
DO696313A	13	D	25	75	16	-
DO696314A	14	D	25	75	16	-
DO696315A	15	D	25	75	16	-
DO696316A	16	D	25	75	16	-
DO696317A	17	D	25	75	16	-
DO696319A	19	D	25	75	16	-
DO696321A	21	D	30	75	16	-
DO696322A	22	D	30	75	16	-

TAILLE

Carré triple 2

Type	C/P	Dessin	D2 mm	L mm	L1 mm	-
------	-----	--------	-------	------	-------	---

Métriques

DO65226005	M5	D	25	55	7	-
DO65226006	M6	D	25	55	7	-
DO65226008	M8	D	25	55	9	-
DO65226010	M10	D	25	55	9	-
DO65226012	M12	D	25	55	11	-
DO65226014	M14	D	25	55	11	-
DO65226016	M16	D	25	55	13	-

TAILLE

Carré triple longues 3

Type	C/P	Dessin	D2 mm	L mm	L1 mm	-
------	-----	--------	-------	------	-------	---

Métriques

DO65227005	M5	D	25	100	7	-
DO65227006	M6	D	25	100	7	-
DO65227008	M8	D	25	100	9	-
DO65227010	M10	D	25	100	9	-
DO65227012	M12	D	25	100	11	-
DO65227014	M14	D	25	100	11	-
DO65227016	M16	D	25	100	13	-

TAILLE

Carré triple extra longues 3

Type	C/P	Dessin	D2 mm	L mm	L1 mm	-
------	-----	--------	-------	------	-------	---

Métriques

DO65228008	M8	D	25	120	9	-
DO65228010	M10	D	25	120	9	-
DO65228012	M12	D	25	120	11	-
DO65228018	M18	D	25	120	14	-

TAILLE

Cardan, empreinte 6 pans 4

Type	C/P mm	Dessin	D2 mm	L mm	L1 mm	-
------	--------	--------	-------	------	-------	---

Métriques

DO65121006	6	E	28	75	13	-
DO65121007	7	E	28	75	13	-
DO65121008	8	E	28	75	20	-
DO65121009	9	E	28	75	20	-
DO65121010	10	E	28	75	20	-
DO65121011	11	E	28	75	20	-
DO65121012	12	E	28	75	20	-
DO65121013	13	E	28	75	20	-
DO65121014	14	E	28	75	20	-
DO65121015	15	E	28	75	20	-
DO65121016	16	E	28	75	20	-
DO65121017	17	E	28	75	20	-
DO65121018	18	E	28	75	20	-
DO65121019	19	E	28	75	20	-

TAILLE

Profile Ribe 5

Type	C/P	Dessin	D2 mm	L mm	L1 mm	-
------	-----	--------	-------	------	-------	---

Métriques

DO65326006	M6	F	25	55	5	-
DO65326007	M7	F	25	55	6,5	-
DO65326008	M8	F	25	55	7,5	-
DO65326010	M10	F	25	55	9	-
DO65326012	M12	F	25	55	10	-
DO65326014	M14	F	25	55	12	-
DO65326016	M16	F	25	55	14	-
DO65326018	M18	F	25	55	16	-



1



2



3



4



5

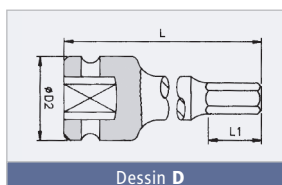

Dessin D

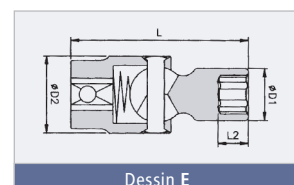

Dessin E

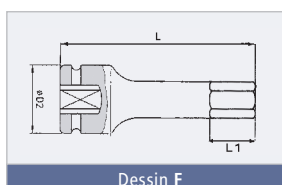

Dessin F

Douilles à choc

1/2"



1



2

TAILLE							1
Douille porte-taroud							
Type	□ A mm	Dessin	Ø D1 mm	Ø D2 mm	Ø d mm	L mm	

Métriques						
DO6322B001	3,4	D	22	22	4,5	40
DO6322B002	4,9	D	22	22	6,0	45
DO6322B003	5,5	D	22	22	7,0	45
DO6322B004	6,2	D	22	22	8,0	45
DO6322B005	7,0	D	22	22	9,0	45
DO6322B006	8,0	D	22	22	10,0	45
DO6322B007	9,0	D	22	22	11,0	45
DO6322B008	9,0	D	22	22	12,0	50
DO6322B009	11,0	D	22	22	14,0	52

Prise goujon				
Type	Taille	D1 mm	D2 mm	L mm
DO69782010	M6 x 1,0	25	13	55
DO69782018	M8 x 1,25	25	15	55
DO69782021	M10 x 1,25	25	18	55
DO69782022	M10 x 1,5	25	17	55
DO69782027	M12 x 1,75	25	19	55
DO69782030	M14 x 1,5	25	23	55
DO69782031	M14 x 2,0	25	22	55
DO69782034	M16 x 1,5	30	28	75
DO69782035	M16 x 2,0	30	27	75
DO69782040	M20 x 1,5	30	30	75
DO69782041	M20 x 2,5	30	30	75

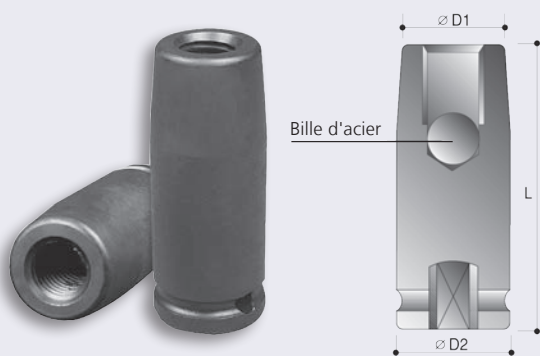

Douilles pour depose de boulon de roue

2

Type	C/P mm	Dessin	D2 mm	D1 mm	L mm	L1 mm
Métriques						
DO69782090	17	H	24	24	38	17
DO69782091	18,5	H	25	25	38	17
DO69782092	20	H	26	26	38	22
DO69782093	21,5	H	28,5	28,5	38	22
DO69782094	23	H	30	30	38	22
DO69782095	24,5	H	31	31	38	22
DO69782096	26	H	32	32	38	22
DO69782206	17	H	25	21,6	55	21
DO69782209	18,5	H	25	23,7	55	21
DO69782212	20	H	25	25,5	55	21
DO69782215	21,5	H	30	27	55	21
DO69782218	23	H	30	28	55	21
DO69782221	24,5	H	30	30	55	21
DO69782224	26	H	30	30	55	17
DO69782227	27,5	H	30	33	55	17
DO69782507	17	H	25	23	55	22
DO69782510	18,5	H	25	25	55	22
DO69782513	20	H	25	26	55	22
DO69782516	21,5	H	30	28	55	22
DO69782520	23	H	30	30	55	22
DO69782523	23	H	30	30,5	55	22
DO69782526	26	H	30	32	55	21

Application: douilles pour depose de boulons de roues

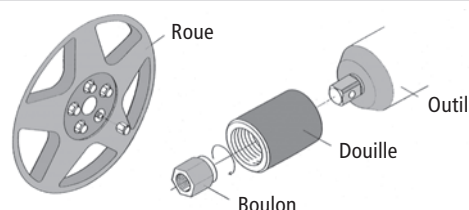

Joint torique clavette

DO1012-0-000

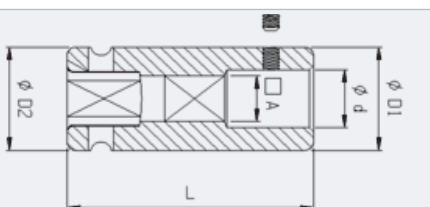

Dessin D

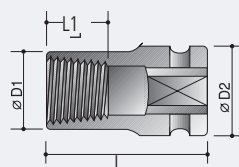



Dessin H

Douilles à choc

 3/4"

TAILLE						
4-Pans 						1
Type	C/P mm	Dessin	D1 mm	D2 mm	L mm	L2 mm
Métriques						
DO63045016	16	B	40	40	52	22
DO63045017	17	B	40	40	52	22
DO63045019	19	B	40	40	52	22
DO63045020	20	B	42	42	52	22
DO63045021	21	B	42	42	52	22
DO63045024	24	C	47	44	52	24

TAILLE						
6-Pans normales 						2
Type	C/P mm	Dessin	D1 mm	D2 mm	L mm	L2 mm
Métriques						
DO3034-0-013	13	A	25	44	50	9
DO3034-0-014	14	A	25	44	50	11
DO3034-0-015	15	A	26	44	50	11
DO3034-0-016	16	A	27	44	50	11
DO3034-0-017	17	A	31	44	50	12
DO3034-0-018	18	A	32	44	50	13
DO3034-0-019	19	A	33	44	50	13
DO3034-0-020	20	A	34	44	50	14
DO3034-0-021	21	A	35	44	50	15
DO3034-0-022	22	A	37	44	50	15
DO3034-0-023	23	A	38	44	50	16
DO3034-0-024	24	A	40	44	50	16
DO3034-0-025	25	A	40	44	50	16
DO3034-0-026	26	A	41	44	50	16
DO3034-0-027	27	A	43	44	54	19
DO3034-0-028	28	B	44	44	54	19
DO3034-0-029	29	C	45	44	54	21
DO3034-0-030	30	C	47	44	54	21
DO3034-0-031	31	C	48	44	56	21
DO3034-0-032	32	C	49	44	56	22
DO3034-0-033	33	C	51	44	56	22
DO3034-0-034	34	C	52	44	56	22
DO3034-0-035	35	C	53	44	56	22
DO3034-0-036	36	C	54	44	56	25
DO3034-0-037	37	C	56	44	58	25
DO3034-0-038	38	C	57	44	58	25
DO3034-0-041	41	C	60	44	58	27
DO3034-0-042	42	C	62	44	58	27
DO3034-0-043	43	C	63	44	63	27
DO3034-0-046	46	C	67	44	63	30
DO3034-0-047	47	C	68	44	68	30
DO3034-0-048	48	C	69	44	68	30
DO3034-0-050	50	C	71	54	72	32
DO3034-0-055	55	C	77	54	74	35
DO3034-0-060	60	C	84	54	75	37
DO3034-0-063	63	C	86	54	75	37
DO3034-0-065	65	C	88	54	78	40
DO3034-0-067	67	C	90	54	80	40

TAILLE						
6-Pans normales 						3
Type	C/P Pouce	Dessin	D1 mm	D2 mm	L mm	L2 mm
Pouce						
DO3034-0-11/16	11/16"	A	29	38	50	12
DO3034-0-3/4	3/4"	A	30	38	50	14
DO3034-0-13/16	13/16"	A	32	38	52	16
DO3034-0-7/8	7/8"	A	34	38	52	16
DO3034-0-15/16	15/16"	A	36	38	52	16
DO3034-0-1 1/8	1 1/8"	B	42	42	52	20
DO3034-0-1 3/16	1 3/16"	B	44	44	52	20
DO3034-0-1 1/4	1 1/4"	B	44	44	52	20
DO3034-0-1	1"	C	40	38	52	16
DO3034-0-1 1/16	1 1/16"	C	40	38	52	16
DO3034-0-1 5/16	1 5/16"	C	47	44	56	23
DO3034-0-1 3/8	1 3/8"	C	50	44	56	23
DO3034-0-1 7/16	1 7/16"	C	51	44	56	23
DO3034-0-1 1/2	1 1/2"	C	53	44	56	23
DO3034-0-1 3/4	1 3/4"	C	65	44	62	27
DO3034-0-1 13/16	1 13/16"	C	67	44	56	32

TAILLE						
6-Pans profonde 						4
Type	C/P mm	Dessin	D1 mm	D2 mm	L mm	L2 mm
Métriques						
DO3034-1-013	13	A	25	44	95	13
DO3034-1-014	14	A	25	44	95	14
DO3034-1-015	15	A	26	44	95	15
DO3034-1-017	17	A	31	44	95	17
DO3034-1-018	18	A	32	44	95	18
DO3034-1-019	19	A	33	44	95	19
DO3034-1-020	20	A	34	44	95	20
DO3034-1-021	21	A	35	44	95	21
DO3034-1-022	22	A	37	44	95	22
DO3034-1-023	23	A	38	44	95	23
DO3034-1-024	24	A	39,5	44	95	24
DO3034-1-025	25	A	40	44	95	25
DO3034-1-026	26	A	41	44	95	26
DO3034-1-027	27	A	43	44	95	27
DO3034-1-028	28	B	44	44	95	28
DO3034-1-029	29	C	45	44	95	29
DO3034-1-030	30	C	47	44	95	30
DO3034-1-031	31	C	48	44	95	31
DO3034-1-032	32	C	49	44	95	32

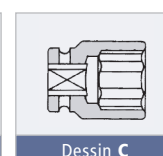
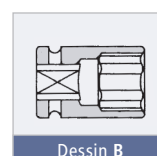
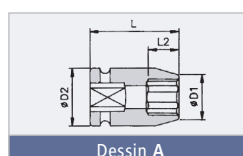

Douilles à choc

□ 3/4"



Douilles à choc, normales



1



2

TAILLE						
6-Pans profonde (suite)						1
Type	C/P mm	Dessin	D1 mm	D2 mm	L mm	L2 mm
Métriques						
DO3034-1-033	33	C	51	44	95	33
DO3034-1-034	34	C	52	44	95	34
DO3034-1-035	35	C	53	44	95	35
DO3034-1-036	36	C	54	44	95	36
DO3034-1-037	37	C	56	44	95	37
DO3034-1-038	38	C	57	44	95	38
DO3034-1-039	39	C	58	44	95	38
DO3034-1-040	40	C	58	44	95	38
DO3034-1-041	41	C	60	44	95	38
DO3034-1-042	42	C	62	44	95	38
DO3034-1-043	43	C	63	44	95	38
DO3034-1-044	44	C	65	44	95	38
DO3034-1-046	46	C	67	44	95	38
DO3034-1-047	47	C	68	44	95	38
DO3034-1-048	48	C	69	44	95	38
DO3034-1-049	49	C	70	44	95	38
DO3034-1-050	50	C	71	54	95	38
DO3034-1-052	52	C	74	54	95	40
DO3034-1-055	55	C	77	54	100	40
DO3034-1-060	60	C	84	54	105	42
DO3034-1-065	65	C	88	54	105	66

TAILLE						
6-Pans extra longues						2
Type	C/P mm	Dessin	D1 mm	D2 mm	L mm	L2 mm
Métriques						
DO61145024	24	G	38,5	44	270	24
DO61145027	27	G	42	44	270	27
DO61145030	30	G	45	44	270	30
DO61145032	32	G	47	44	270	32
DO61145033	33	G	48	44	270	32
DO61145036	36	G	53,5	44	270	32
DO61146024	24	G	38,5	44	400	24
DO61146027	27	G	42	44	400	27
DO61146030	30	G	45	44	400	30
DO61146032	32	G	47	44	400	32
DO61146033	33	G	48	44	400	32
DO61146036	36	G	53,5	44	400	32

TAILLE						
6-Pans profonde						1
Type	C/P Pouce	Dessin	D1 mm	D2 mm	L mm	L2 mm
Inch						
DO3034-1-13/16	13/16"	A	32	38	85	23
DO3034-1-7/8	7/8"	A	34	38	85	23
DO3034-1-15/16	15/16"	A	36	38	85	41
DO3034-1-1	1"	C	40	38	85	41
DO3034-1-1 1/8	1 1/8"	B	42	42	85	52
DO3034-1-1 3/16	1 3/16"	B	44	44	85	52
DO3034-1-1 1/4	1 1/4"	B	44	44	85	52
DO3034-1-1 5/16	1 5/16"	C	47	44	85	52
DO3034-1-1 7/16	1 7/16"	C	51	44	85	52
DO3034-1-1 1/2	1 1/2"	C	53	44	85	60

Joint torique clavette

DO1034-0-000

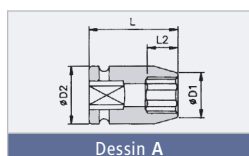

Dessin A

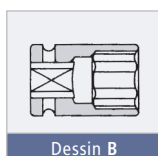

Dessin B

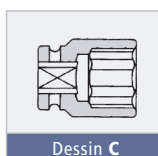

Dessin C



Dessin G

Douilles à choc



Douille à empreinte 6 pans

3/4"

TAILLE						
6-Pans paroi mince profonde						1

Type	C/P mm	Dessin	D1 mm	D2 mm	L mm	L2 mm
------	--------	--------	-------	-------	------	-------

Métriques

DO61141017	17	A	25,5	44	95	17
DO61141019	19	A	28,5	44	95	19
DO61141022	22	A	33,5	44	95	22
DO61141024	24	A	36,5	44	95	24
DO61141027	27	A	40,5	44	95	27
DO61141030	30	A	43,5	44	95	30
DO61141032	32	B	46,5	44	95	32
DO61141033	33	B	47,5	44	95	33
DO61141035	35	B	51	44	95	35
DO61141036	36	B	52	44	95	36
DO61141038	38	B	54	44	95	38
DO61141041	41	B	57	44	95	38

TAILLE						
6-Pans extreme paroi mince profonde						1

Type	C/P mm	Dessin	D1 mm	D2 mm	L mm	L2 mm
------	--------	--------	-------	-------	------	-------

Pouce

DO61142027	27	A	40	43	108	43
DO61142032	32	B	45	45	108	43
DO61142041	41	C	54,5	45	108	43

TAILLE						
Empreinte 6-Pans (Inbus)						2

Type	C/P mm	Dessin	D2 mm	L mm	L1 mm	-
------	--------	--------	-------	------	-------	---

Métriques

DO696510A	10	D	44	100	20	-
DO696512A	12	D	44	100	20	-
DO696514A	14	D	44	100	20	-
DO696517A	17	D	44	100	20	-
DO696519A	19	D	44	100	20	-
DO696522A	22	D	44	100	20	-
DO696524A	24	D	44	100	20	-
DO696527A	27	D	44	100	20	-
DO696530A	30	D	44	100	20	-
DO696532A	32	D	44	100	20	-
DO696536A	36	D	44	100	20	-

TAILLE						
8-Pans						3

Type	C/P mm	Dessin	D1 mm	D2 mm	L mm	L2 mm
------	--------	--------	-------	-------	------	-------

Métriques

DO63645019	19	B	41	41	52	15
DO63645024	24	C	46	44,5	52	20
DO63645027	27	C	53	44,5	56	24
DO63645030	30	C	60	44,5	60	28
DO63645032	32	C	60	44,5	60	28
DO63645038	38	C	70	44,5	64	32

TAILLE						
12-Pans profonde						4

Type	C/P mm	Dessin	D1 mm	D2 mm	L mm	L2 mm
------	--------	--------	-------	-------	------	-------

Métriques

DO65847013	13	A	24,5	44	95	13
DO65847014	14	A	25,5	44	95	14
DO65847015	15	A	27	44	95	15
DO65847016	16	A	28	44	95	16
DO65847017	17	A	29,5	44	95	17
DO65847018	18	A	31	44	95	18
DO65847019	19	A	32	44	95	19
DO65847020	20	A	34	44	95	20
DO65847021	21	A	35	44	95	21
DO65847022	22	A	37	44	95	22
DO65847023	23	A	38	44	95	23
DO65847024	24	A	39	44	95	24
DO65847025	25	A	41	44	95	25
DO65847026	26	A	42	44	95	26
DO65847027	27	A	43	44	95	27
DO65847028	28	B	44	44	95	28
DO65847029	29	C	46	44	95	29
DO65847030	30	C	47	44	95	30
DO65847031	31	C	48	44	95	31
DO65847032	32	C	49	44	95	32
DO65847033	33	C	51	44	95	33
DO65847034	34	C	52	44	95	34
DO65847035	35	C	53	44	95	35
DO65847036	36	C	54	44	95	36
DO65847037	37	C	56	44	95	37
DO65847038	38	C	57	44	95	38
DO65847039	39	C	58	44	95	38
DO65847040	40	C	59,5	44	95	38
DO65847041	41	C	61	44	95	38
DO65847042	42	C	62	44	95	38
DO65847043	43	C	63,5	44	95	38
DO65847044	44	C	64,5	44	95	38
DO65847045	45	C	65,5	44	95	38



1



2



3



4

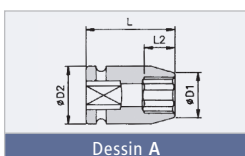

Dessin A

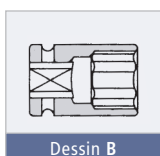

Dessin B

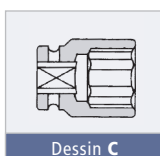

Dessin C

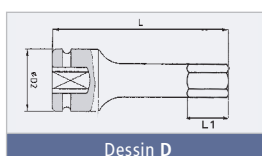

Dessin D

Douilles à choc

□ 3/4"



Douilles à choc, normales



1



2



3

TAILLE

12-Pans profonde (suite)



1

Type	C/P mm	Dessin	D1 mm	D2 mm	L mm	L2 mm
------	--------	--------	-------	-------	------	-------

Métriques

DO65847046	46	C	66,5	44	100	38
DO65847047	47	C	68	44	100	38
DO65847048	48	C	69	44	100	38
DO65847049	49	C	70	44	100	38
DO65847050	50	C	71	54	100	38
DO65847051	51	C	72	54	100	40
DO65847052	52	C	74	54	100	40
DO65847053	53	C	75	54	100	40
DO65847054	54	C	77	54	100	40
DO65847055	55	C	78	54	105	40
DO65847056	56	C	79	54	105	40
DO65847057	57	C	80	54	105	40
DO65847058	58	C	81	54	105	40
DO65847060	60	C	84	54	105	42
DO65847063	63	C	87	54	105	42
DO65847065	65	C	90	54	105	66
DO65847067	67	C	92	54	105	66
DO65847068	68	C	94	54	105	66
DO65847070	70	C	96	54	105	66
DO65847073	73	C	100	54	108	66
DO65847075	75	C	102	64	108	68

TAILLE

12-Pans normales



2

Type	C/P mm	Dessin	D1 mm	D2 mm	L mm	L2 mm
------	--------	--------	-------	-------	------	-------

Métriques

DO63845013	13	A	23	44	50	12
DO63845014	14	A	24	44	50	12
DO63845015	15	A	26	44	50	12
DO63845016	16	A	27	44	50	12
DO63845017	17	A	28	44	50	12
DO63845018	18	A	29	44	50	12
DO63845019	19	A	30	44	50	14
DO63845020	20	A	31	44	52	16
DO63845021	21	A	32	44	52	16
DO63845022	22	A	34	44	52	16
DO63845023	23	A	35	44	52	16
DO63845024	24	A	36	44	52	18
DO63845025	25	B	38	44	52	18
DO63845026	26	C	40	44	52	23
DO63845027	27	C	40	44	52	23
DO63845028	28	C	42	44	52	23
DO63845029	29	C	43	44	52	23
DO63845030	30	C	43	44	52	23
DO63845031	31	C	44	44	56	24
DO63845032	32	C	45	44	56	24
DO63845033	33	C	46	44	56	24
DO63845034	34	C	48	44	56	24

TAILLE

12-Pans normales (suite)



2

Type	C/P mm	Dessin	D1 mm	D2 mm	L mm	L2 mm
------	--------	--------	-------	-------	------	-------

Métriques

DO63845035	35	C	50	44	56	24
DO63845036	36	C	51	44	56	24
DO63845037	37	C	52	44	56	24
DO63845038	38	C	53	44	56	24
DO63845039	39	C	55	44	62	28
DO63845041	41	C	58	44	62	28
DO63845042	42	C	61	44	62	28
DO63845043	43	C	63	44	62	28
DO63845046	46	C	67	44	68	33
DO63845050	50	C	71	44	70	34
DO63845055	55	C	77	54	74	35
DO63845056	56	C	77	54	74	35
DO63845060	60	C	84	54	75	35
DO63845063	63	C	86	54	78	37
DO63845065	65	C	88	54	78	38
DO63845067	67	C	90	54	80	40
DO63845070	70	C	96	54	80	40

TAILLE

Torx® intérieure



3

Type	C/P	Dessin	D2 mm	L mm	L1 mm	-
------	-----	--------	-------	------	-------	---

DO64742050	T50	F	44	100	5,0	-
DO64742055	T55	F	44	100	5,5	-
DO64742060	T60	F	44	100	8,0	-
DO64742070	T70	F	44	100	9,4	-
DO64742080	T80	F	44	100	10,5	-
DO64742090	T90	F	44	100	11,8	-
DO64742100	T100	F	44	100	13,1	-

Torx® est une marque commerciale de Textron.

Prise Goujon

Type	Taille	D1 mm	D2 mm	L mm
DO69784162	M6 x 2	29	44	100
DO69784203	M20 x 2,5	35	44	100
DO69784241	M24 x 1,5	37	44	100
DO69784244	M24 x 3	37	44	100
DO69784305	M30 x 3,5	43	44	100

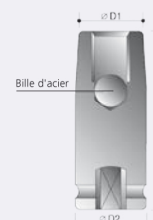

.....▶

Douilles à choc

1"

TAILLE						
4-Pans						1
Type	C/P mm	Dessin	D1 mm	D2 mm	L mm	L2 mm
Métriques						
DO63055017	17	B	52	52	57	24
DO63055019	19	B	52	52	57	24
DO63055020	20	B	52	52	57	24
DO63055021	21	B	52	52	57	24

TAILLE						
6-Pans normales						2
Type	C/P mm	Dessin	D1 mm	D2 mm	L mm	L2 mm
Métriques						
DO4010-0-017	17	A	34	54	60	12
DO4010-0-018	18	A	35	54	60	13
DO4010-0-019	19	A	35,5	54	60	13
DO4010-0-020	20	A	37	54	60	14
DO4010-0-021	21	A	38	54	60	15
DO4010-0-022	22	A	40	54	60	15
DO4010-0-023	23	A	41	54	60	16
DO4010-0-024	24	A	42	54	60	18
DO4010-0-025	25	A	43	54	60	18
DO4010-0-026	26	A	44,5	54	60	18
DO4010-0-027	27	A	46	54	60	19
DO4010-0-028	28	A	47	54	62	19
DO4010-0-029	29	A	48	54	62	19
DO4010-0-030	30	A	50	54	62	21
DO4010-0-031	31	A	51	54	62	21
DO4010-0-032	32	A	52	54	62	22
DO4010-0-033	33	A	53	54	62	22
DO4010-0-034	34	C	55	54	62	22
DO4010-0-035	35	C	56	54	65	22
DO4010-0-036	36	C	57	54	67	25
DO4010-0-037	37	C	59	54	67	25
DO4010-0-038	38	C	59,5	54	67	25
DO4010-0-039	39	C	60	54	70	25
DO4010-0-040	40	C	62	54	70	25
DO4010-0-041	41	C	64	54	70	27
DO4010-0-042	42	C	65	54	74	27
DO4010-0-043	43	C	66	54	74	27
DO4010-0-045	45	C	68	54	74	27
DO4010-0-046	46	C	69,5	54	76	30
DO4010-0-047	47	C	72	54	76	32
DO4010-0-048	48	C	73	54	76	32
DO4010-0-050	50	C	74	54	80	35
DO4010-0-052	52	C	77	54	84	35

TAILLE						
6-Pans normales (suite)						2
Type	C/P mm	Dessin	D1 mm	D2 mm	L mm	L2 mm
Métriques						
DO4010-0-053	53	C	78	54	84	35
DO4010-0-054	54	C	79	54	84	35
DO4010-0-055	55	C	81	54	84	35
DO4010-0-056	56	C	83	54	84	40
DO4010-0-057	57	C	84	54	84	40
DO4010-0-058	58	C	85	54	87	40
DO4010-0-060	60	C	87	54	87	42
DO4010-0-062	62	C	89	54	87	42
DO4010-0-063	63	C	90	54	87	42
DO4010-0-065	65	C	93	54	90	42
DO4010-0-070	70	C	100	54	96	42
DO4010-0-075	75	C	106	86	98	45
DO4010-0-080	80	C	112	86	100	48
DO4010-0-085	85	C	118	86	105	52
DO4010-0-090	90	C	125	86	105	52
DO4010-0-095	95	C	131	86	115	52
DO4010-0-100	100	C	137	95	115	58
DO4010-0-105	105	C	143	95	115	58

TAILLE						
6-Pans normales						2
Type	C/P Pouce	Dessin	D1 mm	D2 mm	L mm	L2 mm
Pouce						
DO4010-0-1	1 1/8"	A	42	51	58	18
DO4010-0-1 1/8	1 1/8"	A	46	51	58	19
DO4010-0-1 5/16	1 5/16"	C	53	52	62	21
DO4010-0-1 7/16	1 7/16"	C	56	52	62	26
DO4010-0-1 1/2	1 1/2"	C	58	52	62	26
DO4010-0-1 11/16	1 11/16"	C	65	52	64	27
DO4010-0-1 7/8	1 7/8"	C	70	58	66	28
DO4010-0-2 1/16	2 1/16"	C	75	58	70	31
DO4010-0-2 1/4	2 1/4"	C	84	62	75	34
DO4010-0-2 7/16	2 7/16"	C	89	62	78	35
DO4010-0-2 1/2	2 1/2"	C	91	62	80	36
DO4010-0-2 7/8	2 7/8"	C	102	62	87	41

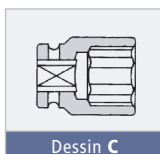
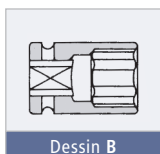
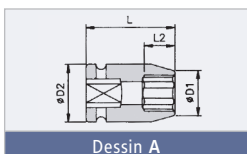

Douilles à choc

1"



1



2

TAILLE

6-Pans profonde

Type	C/P mm	Dessin	D1 mm	D2 mm	L mm	L2 mm
------	--------	--------	-------	-------	------	-------

Métriques

DO4010-1-017	17	A	34	54	100	17
DO4010-1-018	18	A	34	54	100	18
DO4010-1-019	19	A	35,5	54	100	19
DO4010-1-020	20	A	36,5	54	100	20
DO4010-1-021	21	A	37,5	54	100	21
DO4010-1-022	22	A	40	54	100	22
DO4010-1-023	23	A	41	54	100	23
DO4010-1-024	24	A	42	54	100	24
DO4010-1-025	25	A	43	54	100	25
DO4010-1-026	26	A	44,5	54	100	26
DO4010-1-027	27	A	46	54	100	27
DO4010-1-028	28	A	47	54	100	28
DO4010-1-029	29	A	48	54	100	29
DO4010-1-030	30	A	50	54	100	30
DO4010-1-031	31	A	51	54	100	31
DO4010-1-032	32	A	52	54	100	32
DO4010-1-033	33	A	53	53	100	33
DO4010-1-034	34	C	55	54	100	34
DO4010-1-035	35	C	56	54	100	35
DO4010-1-036	36	C	57	54	100	36
DO4010-1-037	37	C	57	54	100	37
DO4010-1-038	38	C	59,5	54	100	38
DO4010-1-039	39	C	61	54	100	38
DO4010-1-040	40	C	62	54	100	38
DO4010-1-041	41	C	64	54	100	38
DO4010-1-042	42	C	65	54	100	38
DO4010-1-046	46	C	69,5	54	100	38
DO4010-1-047	47	C	71,5	54	100	38
DO4010-1-048	48	C	72,5	54	100	38
DO4010-1-050	50	C	75	54	100	38
DO4010-1-054	54	C	80	54	100	40
DO4010-1-055	55	C	81	54	100	40
DO4010-1-056	56	C	82	54	105	40
DO4010-1-058	58	C	85	54	105	40
DO4010-1-060	60	C	87	54	120	42
DO4010-1-065	65	C	93	54	125	42
DO4010-1-070	70	C	100	54	125	42
DO4010-1-075	75	C	106	86	135	45
DO4010-1-080	80	C	112	86	135	48
DO4010-1-085	85	C	118	86	140	52
DO4010-1-090	90	C	125	86	140	52
DO4010-1-095	95	C	131	86	140	52
DO4010-1-100	100	C	137	95	140	58
DO4010-1-105	105	C	143	95	155	58
DO4010-1-110	110	C	149	95	155	60
DO4010-1-115	115	C	155	95	155	62

TAILLE

6-Pans profonde

Type	C/P Pouce	Dessin	D1 mm	D2 mm	L mm	L2 mm
------	-----------	--------	-------	-------	------	-------

Pouce

DO4010-1-15/16	15/16"	A	40	51	90	21
DO4010-1-1 1/16	1 1/16"	A	44	51	90	23
DO4010-1-1 3/16	1 3/16"	A	48	51	90	40
DO4010-1-1 5/16	1 5/16"	C	53	52	90	40
DO4010-1-1 1/2	1 1/2"	C	58	52	92	54

TAILLE

6-Pans paroi mince profonde

Type	C/P mm	Dessin	D1 mm	D2 mm	L mm	L2 mm
------	--------	--------	-------	-------	------	-------

Métriques

DO61151019	19	A	33	54	100	19
DO61151024	24	A	38	54	100	24
DO61151027	27	A	42,5	54	100	27
DO61151028	28	A	43	54	100	28
DO61151030	30	A	45	54	100	30
DO61151032	32	A	47	54	100	32
DO61151033	33	A	49	54	100	33
DO61151036	36	A	52	54	100	36
DO61151041	41	C	57	54	100	38

TAILLE

6-Pans extra profonde

Type	C/P mm	Dessin	D1 mm	D2 mm	L mm	L2 mm
------	--------	--------	-------	-------	------	-------

Métriques

DO60559024	24	B	42	54	270	24
DO60559026	26	B	44	54	270	26
DO60559027	27	B	45	54	270	27
DO60559030	30	B	50	54	270	30
DO60559032	32	B	52	54	270	32
DO60559033	33	B	52	54	270	32

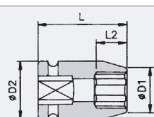

Dessin A

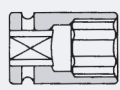

Dessin B

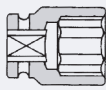

Dessin C

Douilles à choc

1"

TAILLE						
8-Pans						1
Type	C/P mm	Dessin	D1 mm	D2 mm	L mm	L2 mm
Métriques						
DO63655019	19	A	45	54	60	13
DO63655024	24	A	52	54	60	18
DO63655027	27	C	56,5	54	60	19
DO63655030	30	C	61	54	62	21
DO63655032	32	C	64	54	62	22
DO63655035	35	C	68,5	58	65	22
DO63655038	38	C	73	58	67	24
DO63655046	46	C	86	62	76	30

TAILLE						
12-Pans normales						2
Type	C/P mm	Dessin	D1 mm	D2 mm	L mm	L2 mm
Métriques						
DO65855016	16	A	32	54	60	11
DO65855017	17	A	34	54	60	11
DO65855018	18	A	35	54	60	13
DO65855019	19	A	36	54	60	13
DO65855020	20	A	37	54	60	13
DO65855021	21	A	38	54	60	15
DO65855022	22	A	39	54	60	15
DO65855023	23	A	40	54	60	15
DO65855024	24	A	41	54	60	18
DO65855025	25	A	43	54	60	18
DO65855026	26	A	44,5	54	60	18
DO65855027	27	A	45	54	60	19
DO65855028	28	A	46,5	54	62	19
DO65855029	29	A	48	54	62	19
DO65855030	30	A	50	54	62	21
DO65855031	31	A	51	54	62	21
DO65855032	32	A	52	54	62	22
DO65855033	33	A	53	54	62	22
DO65855034	34	C	55	54	62	22
DO65855035	35	C	56	54	65	22
DO65855036	36	C	57	54	67	24
DO65855037	37	C	59	54	67	24
DO65855038	38	C	60	54	67	24
DO65855039	39	C	61	54	70	24
DO65855040	40	C	62	54	70	24
DO65855041	41	C	63,5	54	70	27
DO65855042	42	C	65	54	74	27
DO65855043	43	C	66	54	74	27

TAILLE						
12-Pans normales (suite)						2
Type	C/P mm	Dessin	D1 mm	D2 mm	L mm	L2 mm
Métriques						
DO65855044	44	C	67	54	74	27
DO65855045	45	C	68	54	74	27
DO65855046	46	C	70	58	76	30
DO65855047	47	C	71,5	58	76	30
DO65855048	48	C	72,5	58	76	30
DO65855050	50	C	75	62	80	32
DO65855051	51	C	76	62	80	32
DO65855052	52	C	77	62	84	32
DO65855053	53	C	78	62	84	32
DO65855054	54	C	80	62	84	32
DO65855055	55	C	81	62	84	35
DO65855056	56	C	82	62	84	35
DO65855057	57	C	84	62	84	35
DO65855058	58	C	85	62	87	37
DO65855060	60	C	87	62	87	37
DO65855062	62	C	89	62	87	37
DO65855063	63	C	90	62	87	37
DO65855065	65	C	93	62	90	40
DO65855067	67	C	96	62	92	40
DO65855070	70	C	100	62	96	40
DO65855075	75	C	106	86	98	42
DO65855076	76	C	107	86	100	45
DO65855077	77	C	109	86	100	45
DO65855078	78	C	110	86	100	45
DO65855080	80	C	112	86	100	45
DO65855085	85	C	118	86	105	52
DO65855090	90	C	125	86	105	52
DO65855095	95	C	131	86	105	52
DO65855100	100	C	137	86	110	58
DO65855105	105	C	143	95	110	58
DO65855110	110	C	149	95	115	62
DO65855115	115	C	155	95	115	62

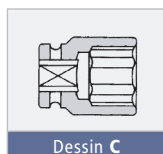
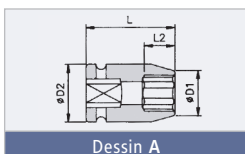

Douilles à choc

1"



1



2

TAILLE 12-Pans profonde

Type	C/P mm	Dessin	D1 mm	D2 mm	L mm	L2 mm
------	--------	--------	-------	-------	------	-------

Métriques

DO65857016	16	A	32	54	100	11
DO65857017	17	A	34	54	100	11
DO65857018	18	A	35	54	100	13
DO65857019	19	A	36	54	100	13
DO65857020	20	A	37	54	100	13
DO65857021	21	A	38	54	100	15
DO65857022	22	A	39	54	100	15
DO65857023	23	A	40	54	100	15
DO65857024	24	A	41	54	100	18
DO65857025	25	A	43	54	100	18
DO65857026	26	A	44,5	54	100	18
DO65857027	27	A	45	54	100	19
DO65857028	28	A	46,5	54	100	19
DO65857029	29	A	48	54	100	19
DO65857030	30	A	50	54	100	21
DO65857031	31	A	51	54	100	21
DO65857032	32	A	52	54	100	22
DO65857033	33	A	53	54	100	22
DO65857034	34	C	55	54	100	22
DO65857035	35	C	56	54	100	22
DO65857036	36	C	57	54	100	24
DO65857037	37	C	59	54	100	24
DO65857038	38	C	60	54	100	24
DO65857039	39	C	61	54	100	24
DO65857040	40	C	62	54	100	24
DO65857041	41	C	63,5	54	100	27
DO65857042	42	C	65	54	100	27
DO65857043	43	C	66	54	100	27
DO65857044	44	C	67	54	100	27
DO65857045	45	C	68	54	100	27
DO65857046	46	C	70	58	100	30
DO65857047	47	C	71,5	58	100	30
DO65857048	48	C	72,5	58	100	30
DO65857050	50	C	75	62	100	32
DO65857051	51	C	76	62	100	32
DO65857052	52	C	77	62	100	32
DO65857053	53	C	78	62	100	32
DO65857054	54	C	80	62	100	32
DO65857055	55	C	81	62	100	35
DO65857056	56	C	82	62	105	35
DO65857057	57	C	84	62	105	35
DO65857058	58	C	85	62	105	37
DO65857060	60	C	87	62	120	37

TAILLE 12-Pans profonde (suite)

Type	C/P mm	Dessin	D1 mm	D2 mm	L mm	L2 mm
------	--------	--------	-------	-------	------	-------

Métriques

DO65857062	62	C	89	62	120	37
DO65857063	63	C	90	62	120	37
DO65857065	65	C	93	62	125	40
DO65857067	67	C	96	62	125	40
DO65857070	70	C	100	62	125	40
DO65857075	75	C	106	86	135	42
DO65857076	76	C	107	86	135	45
DO65857077	77	C	109	86	135	45
DO65857078	78	C	110	86	135	45
DO65857080	80	C	112	86	135	45
DO65857085	85	C	118	86	140	52
DO65857090	90	C	125	86	140	52
DO65857095	95	C	131	86	140	52
DO65857100	100	C	137	86	140	58
DO65857105	105	C	143	95	155	58
DO65857110	110	C	149	95	155	62
DO65857115	115	C	155	95	155	62

TAILLE Empreinte 6-Pans (Inbus)

Type	C/P mm	Dessin	D2 mm	D1 mm	L2 mm
------	--------	--------	-------	-------	-------

Métriques

DO696610A	10	D	54	100	20	-
DO696612A	12	D	54	100	20	-
DO696614A	14	D	54	100	20	-
DO696617A	17	D	54	100	20	-
DO696619A	19	D	54	100	20	-
DO696622A	22	D	54	100	20	-
DO696622B	22	D	54	140	20	-
DO696624A	24	D	54	100	20	-
DO696627A	27	D	54	100	20	-
DO696630A	30	D	54	100	20	-
DO696632A	32	D	54	100	20	-
DO696636A	36	D	54	100	20	-

Joint torique clavette

Type	Embout carré	D2 mm
DO1100-0-000	1"	54
DO1100-0-086	1"	86
DO1100-0-095	1"	95

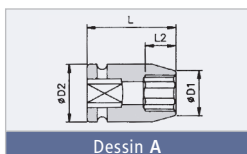

Dessin A

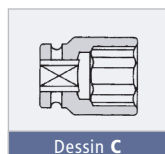

Dessin C

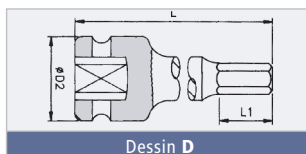

Dessin D

Douilles à choc

□ 1½"



Douille 1½" longueur normale

TAILLE						1
6-Pans normales						

Type	C/P mm	Dessin	D1 mm	D2 mm	L mm	L2 mm
------	--------	--------	-------	-------	------	-------

Métriques

DO5112-0-030	30	A	56	86	78	21
DO5112-0-032	32	A	58	86	78	22
DO5112-0-035	35	A	62	86	78	22
DO5112-0-036	36	A	64	86	78	24
DO5112-0-037	37	A	65	86	78	24
DO5112-0-038	38	A	66	86	78	26
DO5112-0-040	40	A	68	86	78	28
DO5112-0-041	41	A	70	86	80	28
DO5112-0-045	45	A	75	86	84	30
DO5112-0-046	46	A	76	86	84	30
DO5112-0-047	47	A	77	86	84	32
DO5112-0-048	48	A	79	86	84	32
DO5112-0-050	50	A	81	87	87	32
DO5112-0-052	52	A	83	86	87	34
DO5112-0-054	54	B	86	86	90	37
DO5112-0-055	55	B	86	86	90	37
DO5112-0-056	56	B	86	86	92	37
DO5112-0-058	58	C	92	86	92	39
DO5112-0-060	60	C	93	86	92	39
DO5112-0-061	61	C	95	86	95	42
DO5112-0-062	62	C	96	86	95	42
DO5112-0-065	65	C	97	86	95	42
DO5112-0-068	68	C	104	86	100	46
DO5112-0-070	70	C	105	86	100	46
DO5112-0-072	72	C	108	86	108	49
DO5112-0-075	75	C	110	86	108	49
DO5112-0-078	78	C	115	86	115	53
DO5112-0-080	80	C	116	86	115	53
DO5112-0-085	85	C	125	86	118	56
DO5112-0-090	90	C	130	86	123	59
DO5112-0-095	95	C	137	95	123	62
DO5112-0-100	100	C	140	95	130	65
DO5112-0-105	105	C	150	95	130	68
DO5112-0-110	110	C	156	95	135	72
DO5112-0-115	115	C	160	95	140	77
DO5112-0-125	125	C	175	95	140	77

TAILLE						2
6-Pans profonde						

Type	C/P mm	Dessin	D1 mm	D2 mm	L mm	L2 mm
------	--------	--------	-------	-------	------	-------

Métriques

DO5112-1-041	41	A	70	86	115	28
DO5112-1-042	42	A	71	86	115	28
DO5112-1-046	46	A	76	86	115	30
DO5112-1-050	50	A	81	86	135	34
DO5112-1-054	54	B	86	86	140	37
DO5112-1-055	55	B	86	86	140	37
DO5112-1-056	56	B	88	86	140	37
DO5112-1-060	60	C	94	86	150	39
DO5112-1-063	60	C	97	86	150	42
DO5112-1-065	65	C	100	86	150	42
DO5112-1-070	70	C	106	86	160	46
DO5112-1-075	75	C	112	86	170	49
DO5112-1-080	80	C	119	86	170	53
DO5112-1-085	85	C	125	86	170	56
DO5112-1-090	90	C	131	86	170	59
DO5112-1-095	95	C	137	95	180	61
DO5112-1-096	96	C	138	95	180	62
DO5112-1-100	100	C	144	95	190	65
DO5112-1-105	105	C	154	95	190	68
DO5112-1-110	110	C	157	95	200	72
DO5112-1-115	115	C	164	95	210	77
DO5112-1-120	120	C	167	95	210	77
DO5112-1-125	125	C	174	127	210	77



1



2

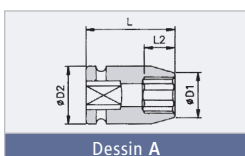

Dessin A

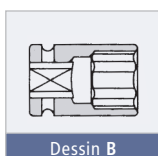

Dessin B

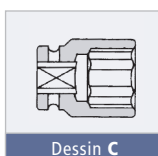

Dessin C

Douilles à choc

1 1/2"

2 1/2"



1



2



3

TAILLE

Empreinte 6-Pans

Type	C/P mm	Dessin	D2 mm	L mm	L1 mm	-
------	--------	--------	-------	------	-------	---

Métriques

DO64866019	19	D	86	105	20	-
DO64866022	22	D	86	105	20	-
DO64866024	24	D	86	105	20	-
DO64866027	27	D	86	105	20	-
DO64866030	30	D	86	105	20	-
DO64866032	32	D	86	105	20	-
DO64866033	33	D	86	105	20	-
DO64866041	41	D	86	105	20	-
DO64866046	46	D	86	105	20	-
DO64866050	50	D	86	105	20	-
DO64866055	55	D	86	105	20	-

DO64865019	19	D	86	120	20	-
DO64865022	22	D	86	120	20	-
DO64865024	24	D	86	120	20	-
DO64865027	27	D	86	120	20	-
DO64865030	30	D	86	120	20	-
DO64865032	32	D	86	120	20	-
DO64865033	33	D	86	120	20	-
DO64865036	36	D	86	120	20	-
DO64865038	38	D	86	120	20	-
DO64865041	41	D	86	120	20	-
DO64865046	46	D	86	120	20	-
DO64865050	50	D	86	120	20	-
DO64865055	55	D	86	120	20	-

Joint torique clavette

DO1112-0-000



TAILLE

6-Pans normales

Type	C/P mm	Dessin	D1 mm	D2 mm	L mm	L2 mm
------	--------	--------	-------	-------	------	-------

Métriques

DO6212-0-060	60	A	99	127	125	37
DO6212-0-065	65	A	105	127	130	40
DO6212-0-070	70	A	110	127	130	40
DO6212-0-075	75	A	118	127	140	42
DO6212-0-077	77	A	122	127	140	45
DO6212-0-080	80	A	124	127	140	45
DO6212-0-085	85	C	130	127	140	52
DO6212-0-090	90	C	136	127	145	52
DO6212-0-095	95	C	143	127	145	52
DO6212-0-100	100	C	149	127	150	58
DO6212-0-105	105	C	155	127	155	58
DO6212-0-110	110	C	161	127	160	60
DO6212-0-115	115	C	167	127	165	62
DO6212-0-120	120	C	176	127	170	67
DO6212-0-125	125	C	184	127	175	72
DO6212-0-130	130	C	188	152	175	72
DO6212-0-135	135	C	195	152	180	77
DO6212-0-140	140	C	204	152	180	77
DO6212-0-145	145	C	207	152	185	83
DO6212-0-150	150	C	214	152	185	83
DO6212-0-155	155	C	224	152	190	90
DO6212-0-160	160	C	227	152	190	90
DO6212-0-165	165	C	234	152	195	95
DO6212-0-170	170	C	244	152	195	95
DO6212-0-175	175	C	247	152	200	100
DO6212-0-180	180	C	254	152	200	100
DO6212-0-185	185	C	257	152	210	105
DO6212-0-190	190	C	265	152	210	105
DO6212-0-200	200	C	275	152	220	110

Joint torique clavette

DO2112-0-000



#5 Spline Embout

TAILLE

6-Pans normales

Type	C/P mm	Dessin	D1 mm	D2 mm	L mm	L2 mm
------	--------	--------	-------	-------	------	-------

Métriques

DO67005027	27	A	48	55	80	24
DO67005030	30	A	51	55	80	24
DO67005032	32	B	55	55	80	24
DO67005041	41	C	67	55	80	24
DO67005050	50	C	75	65	98	38
DO67005055	55	C	79	65	98	38
DO67005060	60	C	86	65	106	46
DO67005070	70	C	99	86	117	57

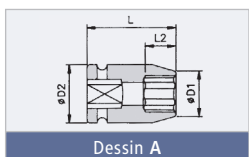

Dessin A

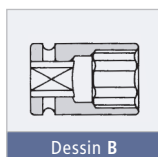

Dessin B

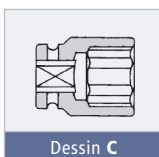

Dessin C

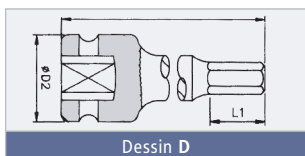

Dessin D

Rallonges



Rallonges à cliquet mâle

Rallonges

Rallonges à cliquet femelle

1

Type	Embout carré	Dessin	D mm	L mm
Métriques				
DO7014-0-050	1/4"	B	13	50
DO7014-0-100	1/4"	B	13	100
DO7014-0-150	1/4"	B	13	150
DO7038-0-075	3/8"	B	19	75
DO7038-0-100	3/8"	B	19	100
DO7038-0-125	3/8"	B	19	125
DO7038-0-150	3/8"	B	19	150
DO7038-0-200	3/8"	B	19	200
DO7038-0-250	3/8"	B	19	250
DO7012-0-075	1/2"	B	25	75
DO7012-0-100	1/2"	B	25	100
DO7012-0-125	1/2"	B	25	125
DO7012-0-150	1/2"	B	25	150
DO7012-0-175	1/2"	B	25	175
DO7012-0-200	1/2"	B	25	200
DO7012-0-250	1/2"	B	25	250
DO7012-0-300	1/2"	B	25	300
DO7012-0-460	1/2"	B	25	460
DO7012-0-610	1/2"	B	25	610
DO7012-0-915	1/2"	B	25	915
DO7034-0-075	3/4"	B	44	75
DO7034-0-100	3/4"	B	44	100
DO7034-0-125	3/4"	B	44	125
DO7034-0-150	3/4"	B	44	150
DO7034-0-175	3/4"	B	44	175
DO7034-0-200	3/4"	B	44	200
DO7034-0-250	3/4"	B	44	250
DO7034-0-300	3/4"	B	44	300
DO7034-0-330	3/4"	B	44	330
DO7034-0-400	3/4"	B	44	400
DO7100-0-075	1"	B	54	75
DO7100-0-100	1"	B	54	100
DO7100-0-125	1"	B	54	125
DO7100-0-150	1"	B	54	150
DO7100-0-175	1"	B	54	175
DO7100-0-200	1"	B	54	200
DO7100-0-250	1"	B	54	250
DO7100-0-300	1"	B	54	300
DO7100-0-330	1"	B	54	330
DO7100-0-350	1"	B	54	350
DO7100-0-400	1"	B	54	400
DO7112-0-125	1 1/2"	B	86	125
DO7112-0-250	1 1/2"	B	86	250
DO7112-0-500	1 1/2"	B	86	500
DO7212-0-125	2 1/2"	B	127	125
DO7212-0-250	2 1/2"	B	127	250
DO7212-0-500	2 1/2"	B	127	500

Les joints toriques clavettes ne sont pas livrés en standard avec les rallonges à cliquet femelle. A commander séparément.

Rallonges à cliquet bille d'acier

2

Type	Embout carré	Dessin	D2 mm	L mm
Métriques				
DO6862075	3/8"	A	19	75
DO6862100	3/8"	A	19	100
DO6862125	3/8"	A	19	125
DO6862150	3/8"	A	19	150
DO6862250	3/8"	A	19	250
DO6863075	1/2"	A	25	75
DO6863100	1/2"	A	25	100
DO6863125	1/2"	A	25	125
DO6863250	1/2"	A	25	250

Rallonges à cliquet mâle

2

Type	Embout carré	Dessin	D2 mm	L mm
Métriques				
DO64524075	1/2"	A	25	75
DO64524100	1/2"	A	25	100
DO64524125	1/2"	A	25	125
DO64524150	1/2"	A	25	150
DO64524200	1/2"	A	25	200
DO64524450	1/2"	A	25	450

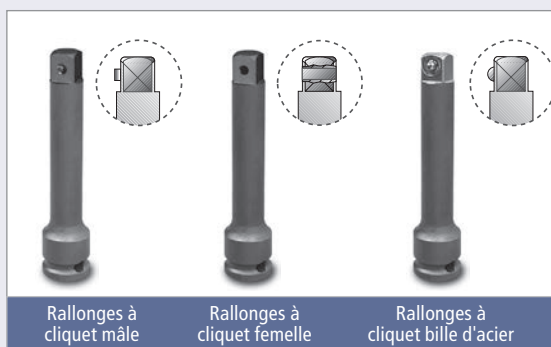
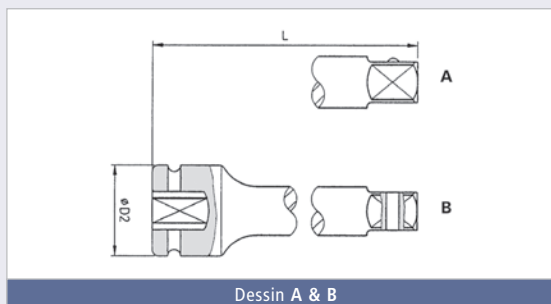

Adaptateurs & cardans



Cardan



1



2



3



4

Rallonges Wobble

Type	Embout carré	Tête	D2 mm	L mm	Type
Métriques					
DO6450F050	1/4"	1/4"	13	50	Rallonge
DO6450F075	1/4"	1/4"	13	75	Rallonge
DO6450F100	1/4"	1/4"	13	100	Rallonge

DO6451F050	3/8"	3/8"	19	50	Rallonge
DO6451F075	3/8"	3/8"	19	75	Rallonge
DO6451F100	3/8"	3/8"	19	100	Rallonge
DO6451F200	3/8"	3/8"	19	200	Rallonge

DO6452F075	1/2"	1/2"	25	75	Rallonge
DO6452F125	1/2"	1/2"	25	125	Rallonge
DO6452F200	1/2"	1/2"	25	200	Rallonge

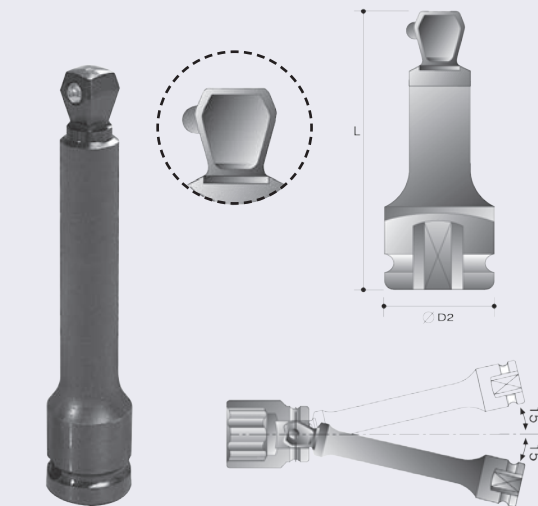

Cliquet bille d'acier

Cardans

Cardans à cliquet mâle

2

Type	Embout carré	Dessin	D2 mm	D1 mm	L mm
Métriques					
DO6781F1T	1/4"	A	16	-	43
DO6782F2T	3/8"	A	21	24	50
DO6783F3T	1/2"	A	29	32	60
DO6784F4T	3/4"	A	44	-	105

Cardans à cliquet femelle

3

Type	Embout carré	Dessin	D2 mm	L mm	-
Métriques					
DO9014-0-000	1/4"	B	16	43	-
DO9038-0-000	3/8"	B	21	50	-
DO9012-0-000	1/2"	B	29	60	-
DO9034-0-000	3/4"	B	44	105	-
DO9100-0-000	1"	B	54	133	-
DO9112-0-000	1 1/2"	B	86	182	-

Les joints toriques clavettes ne sont pas livrés en standard avec les adaptateurs à cliquet. A commander séparément.

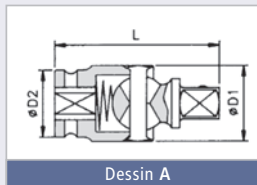

Dessin A

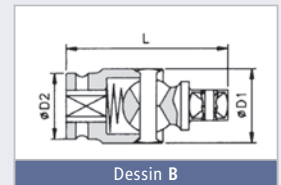

Dessin B

Mandrin à chocs

1

Type	Embout carré	Tête	L mm
DO69121008	3/8"	1/4"	32
DO69121010	3/8"	5/16"	37
DO69121016	3/8"	1/2"	37
DO69122008	1/2"	1/4"	40
DO69122010	1/2"	5/16"	40
DO69122016	1/2"	1/2"	40

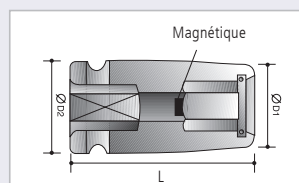

Adaptateurs d'impact

4

Type	Embout carré	Mandrin 6K	Dessin	L mm	D mm
Métriques					
DO69306050	1/4"	1/4"	C	50	9
DO69306075	1/4"	1/4"	C	75	9
DO69306100	1/4"	1/4"	C	100	9
DO69306150	1/4"	1/4"	C	150	9
DO69316050	3/8"	1/4"	C	50	13
DO69316075	3/8"	1/4"	C	75	13
DO69316100	3/8"	1/4"	C	100	13
DO69318075	3/8"	7/16"	D	75	13
DO6932E050	1/2"	1/4"	C	50	17
DO69328075	1/2"	7/16"	D	75	17



Dessin C



Dessin D

Adaptateurs

Adaptateurs

Adaptateurs à cliquet femelle

1

Type	Embout carré	Tête	Dessin	D2 mm	L mm
Métriques					
DO8014-0-038	1/4"	3/8"	A	13	26
DO8038-0-014	3/8"	1/4"	A	22	32
DO8038-0-012	3/8"	1/2"	A	22	36
DO8012-0-034	1/2"	3/4"	A	30	48
DO8012-0-038	1/2"	3/8"	A	26	38
DO8034-0-012	3/4"	1/2"	A	40	58
DO8034-0-100	3/4"	1"	A	40	63
DO8100-0-034	1"	3/4"	A	52	80
DO8100-0-112	1"	1 1/2"	A	52	91
DO8112-0-100	1 1/2"	1"	A	84	95
DO8112-0-212	1 1/2"	2 1/2"	A	86	120
DO8134-0-112	1 3/4"	1 1/2"	A	127	153
DO8212-0-112	2 1/2"	1 1/2"	A	127	138

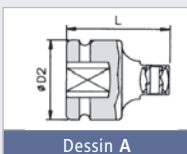

Adaptateurs magnétique

2

Type	Embout carré	Tête	Dessin	D2 mm	L mm
Métriques					
DO69880P12	1/4"	3/8"	A	19	17
DO69880P16	1/4"	1/2"	A	25	22
DO69881P16	3/8"	1/2"	A	25	22
DO69881P20	1/2"	5/8"	A	35	23
DO69882P24	1/2"	3/4"	A	44	30
DO69884P32	3/4"	1"	B	54	35
DO69885P48	1"	1-1/2"	B	86	50
DO69886P80	1-1/2"	2-1/2"	B	127	59
DO69888P01	2-1/2"	3-1/2"	B	176	95

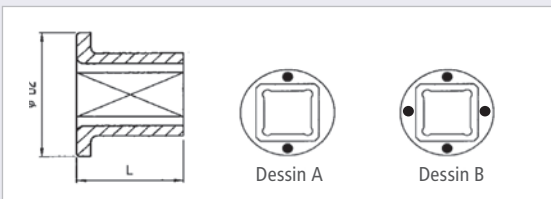

Adaptateurs à changement rapide



Adaptateurs à changement rapide

3

Type	Embout carré	Tête	L mm
Métriques			
DO69110C08	1/4"	1/4"	35
DO69111C12	3/8"	3/8"	46
DO69111C16	3/8"	1/2"	60
DO69112C12	1/2"	3/8"	54
DO69112C16	1/2"	1/2"	60
DO69114C16	3/4"	1/2"	70
DO69114C24	3/4"	3/4"	78
DO69115C24	1"	3/4"	90
DO69115C32	1"	1"	100
DO69115C64	1"	3/4"	300

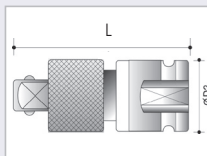

Mandrin à chocs

4

Type	Carr, d'entraînement	Mandrin 6 pans	D2 mm	L mm
Métriques				
DO69121B08	3/8"	1/4"	22	33
DO69122B08	1/2"	1/4"	25	41

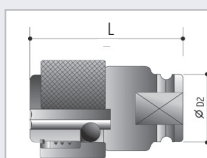

Douilles guidées

□ 3/8"



1



2



3

TAILLE

6-Pans normales



1

Type	C/P mm	Dessin	D1 mm	D2 mm	L mm	L2 mm
------	--------	--------	-------	-------	------	-------

Métriques

DO60910006	6	A	11	19	43	5
DO60910007	7	A	12	19	43	5
DO60910008	8	A	13	19	43	7
DO60910009	9	A	15	19	43	7
DO60910010	10	A	16	19	43	8
DO60910011	11	A	17,5	19	43	9
DO60910012	12	B	19	19	43	9
DO60910013	13	A	20	22	43	9
DO60910014	14	A	21	22	43	9
DO60910015	15	B	22	22	43	11
DO60910016	16	C	24	22	43	11
DO60910017	17	C	25	22	43	11
DO60910018	18	C	26	22	43	11
DO60910019	19	C	27,5	22	43	11
DO60910021	21	C	30	22	43	13

TAILLE

6-Pans normales magnétique



1

Type	C/P mm	Dessin	D1 mm	D2 mm	L mm	L2 mm
------	--------	--------	-------	-------	------	-------

Métriques

DO6091A006	6	A	11	19	43	5
DO6091A007	7	A	12	19	43	5
DO6091A008	8	A	13	19	43	7
DO6091A009	9	A	15	19	43	7
DO6091A010	10	A	16	19	43	8
DO6091A011	11	A	17,5	19	43	9
DO6091A012	12	B	18,5	19	43	9
DO6091A013	13	A	20	22	43	9
DO6091A014	14	A	21	22	43	9
DO6091A015	15	B	22	22	43	11
DO6091A016	16	C	24	22	43	11
DO6091A017	17	C	25	22	43	11
DO6091A018	18	C	26	22	43	11
DO6091A019	19	C	27	22	43	11
DO6091A020	20	C	28	22	43	13
DO6091A021	21	C	30	22	43	13
DO6091A022	22	C	31	22	50	13
DO6091A023	23	C	32	22	50	13
DO6091A024	24	C	34	22	50	13
DO6091A025	25	C	35	22	50	13
DO6091A026	26	C	36	22	50	13
DO6091A027	27	C	38	22	50	13

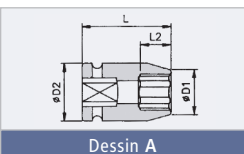

Dessin A

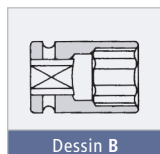

Dessin B

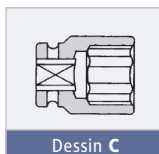

Dessin C

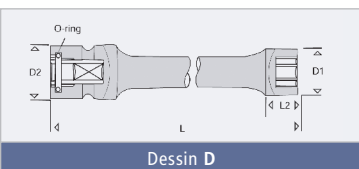

Dessin D

TAILLE

6-Pans longues



2

Type	C/P mm	Dessin	D1 mm	D2 mm	L mm	L2 mm
------	--------	--------	-------	-------	------	-------

Métriques

DO60913006	6	D	10,5	22	100	4
DO60913008	8	D	12,5	22	100	8
DO60913010	10	D	15	22	100	8
DO60913012	12	D	18	22	100	9
DO60913013	13	D	19	22	100	9
DO60913014	14	D	20	22	100	9
DO60913015	15	D	21	22	100	11
DO60913016	16	D	22,5	22	100	11
DO60913017	17	D	24	22	100	11
DO60914006	6	D	10,5	22	150	4
DO60914008	8	D	12,5	22	150	8
DO60914010	10	D	15	22	150	8
DO60914012	12	D	18	22	150	9
DO60914013	13	D	19	22	150	9
DO60914014	14	D	20	22	150	9
DO60914015	15	D	21	22	150	11
DO60914016	16	D	22,5	22	150	11
DO60914017	17	D	24	22	150	11
DO60915006	6	D	10,5	22	200	4
DO60915008	8	D	12,5	22	200	8
DO60915010	10	D	15	22	200	8
DO60915012	12	D	18	22	200	9
DO60915013	13	D	19	22	200	9
DO60915014	14	D	20	22	200	9
DO60915015	15	D	21	22	200	11
DO60915016	16	D	22,5	22	200	11
DO60915017	17	D	24	22	200	11

TAILLE

6-Pans longues magnétique



3

Type	C/P mm	Dessin	D1 mm	D2 mm	L mm	L2 mm
------	--------	--------	-------	-------	------	-------

Métriques

DO6091P006	6	D	11	19	100	3
DO6091P007	7	D	12	19	100	3
DO6091P008	8	D	13	19	100	4
DO6091P009	9	D	15	19	100	4
DO6091P010	10	D	16	19	100	4
DO6091P011	11	D	17,5	19	100	5
DO6091P012	12	D	18,5	19	100	5
DO6091P013	13	D	20	22	100	6
DO6091P014	14	D	21	22	100	6
DO6091P015	15	D	22	22	100	7
DO6091P016	16	D	24	22	100	7
DO6091P017	17	D	25	22	100	7
DO6091R006	6	D	11	19	150	3
DO6091R007	7	D	12	19	150	3
DO6091R008	8	D	13	19	150	4
DO6091R009	9	D	15	19	150	4
DO6091R010	10	D	16	19	150	4
DO6091R011	11	D	17,5	19	150	5
DO6091R012	12	D	18,5	19	150	5
DO6091R013	13	D	20	22	150	6
DO6091R014	14	D	21	22	150	6
DO6091R015	15	D	22	22	150	7
DO6091R016	16	D	24	22	150	7
DO6091R017	17	D	25	22	150	7

Douilles guidées

3/8"

TAILLE 6-Pans longues magnétique (suite) 1

Type	C/P mm	Dessin	D1 mm	D2 mm	L mm	L2 mm
------	--------	--------	-------	-------	------	-------

Métriques

DO6091T007	7	D	12	19	200	3
DO6091T008	8	D	13	19	200	4
DO6091T009	9	D	15	19	200	4
DO6091T010	10	D	16	19	200	4
DO6091T011	11	D	17,5	19	200	5
DO6091T012	12	D	18,5	19	200	5
DO6091T013	13	D	20	22	200	6
DO6091T014	14	D	21	22	200	6
DO6091T015	15	D	22	22	200	7
DO6091T016	16	D	24	22	200	7
DO6091T017	17	D	25	22	200	7

TAILLE 6-Pans profonde magnétique 2

Type	C/P mm	Dessin	D1 mm	D2 mm	L mm	L2 mm
------	--------	--------	-------	-------	------	-------

Métriques

DO6091Q010	10	A	16,0	19	100	5
DO6091Q012	12	A	18,5	19	100	6
DO6091Q013	13	A	20,0	22	100	6
DO6091Q014	14	A	21,0	22	100	6
DO6091Q016	16	A	24,0	22	100	7

TAILLE Torx® intérieure 3

Type	C/P mm	Dessin	L1 mm	D2 mm	L mm	-
------	--------	--------	-------	-------	------	---

DO68811009	T9	F	2,0	22	75	-
DO68811010	T10	F	2,8	22	75	-
DO68811015	T15	F	2,8	22	75	-
DO68811020	T20	F	2,8	22	75	-
DO68811025	T25	F	3,0	22	75	-
DO68811027	T27	F	3,0	22	75	-
DO68811030	T30	F	3,8	22	75	-
DO68811040	T40	F	3,8	22	75	-
DO68811045	T45	F	4,3	22	75	-
DO68811047	T47	F	5,0	22	75	-
DO68811050	T50	F	5,0	22	75	-
DO68811055	T55	F	5,0	22	75	-

Torx® est une marque commerciale de Textron.

TAILLE Torx® extérieure 4

Type	C/P mm	Dessin	D1 mm	D2 mm	L mm	L2 mm
------	--------	--------	-------	-------	------	-------

DO66910005	E5	A	8	19	43	4,5
DO66910006	E6	A	9	19	43	5
DO66910007	E7	A	9,5	19	43	6
DO66910008	E8	A	11	19	43	6,5
DO66910010	E10	A	13	19	43	7,5
DO66910011	E11	A	14	19	43	8
DO66910012	E12	A	15,5	19	43	8,5
DO66910014	E14	A	17,5	22	43	10
DO66910016	E16	A	18,5	22	43	11

Torx® est une marque commerciale de Textron.

TAILLE Empreinte 6-Pans 5

Type	C/P mm	Dessin	L1 mm	D2 mm	L mm	-
------	--------	--------	-------	-------	------	---

Métriques

DO68916003	3	F	11	22	75	-
DO68916004	4	F	11	22	75	-
DO68916005	5	F	11	22	75	-
DO68916006	6	F	11	22	75	-
DO68916007	7	F	16	22	75	-
DO68916008	8	F	16	22	75	-
DO68916009	9	F	16	22	75	-
DO68916010	10	F	16	22	75	-
DO68916011	11	F	16	22	75	-
DO68916012	12	F	16	22	75	-
DO68916013	13	F	16	22	75	-
DO68916014	14	F	16	22	75	-
DO68916015	15	F	16	22	75	-
DO68916016	16	F	16	22	75	-

Prise Goujon

Type	Taille	D1 mm	D2 mm	L mm
DO66A10062	M6 x 1	12,5	22	50
DO66A10083	M8 x 1,25	15	22	50
DO66A10104	M10 x 1,5	17	22	50

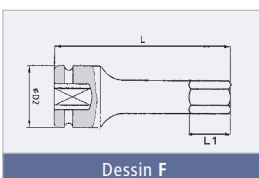
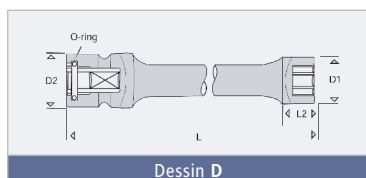
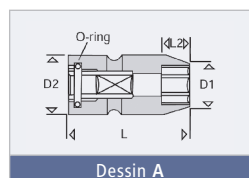
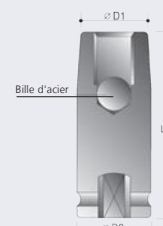

Douilles guidées

□ 1/2"



1



2



3

TAILLE							1
6-Pans normales							
Type	C/P mm	Dessin	D1 mm	D2 mm	L mm	L2 mm	

Métriques						
DO60920012	12	A	20	25	52	12
DO60920013	13	A	21	25	52	12
DO60920014	14	A	22,5	25	52	12
DO60920015	15	A	23,7	30	52	12
DO60920016	16	A	25	30	52	12
DO60920017	17	A	26	30	52	12
DO60920018	18	A	27,5	30	52	12
DO60920019	19	A	28,7	30	52	12
DO60920021	21	B	30	30	52	12
DO60920022	22	C	32	30	52	12
DO60920023	23	C	32	30	52	12
DO60920024	24	C	35	30	52	12
DO60920025	25	C	36	30	57	12
DO60920027	27	C	39	30	57	12
DO60920030	30	C	42	30	62	12
DO60920032	32	C	44	30	62	12

TAILLE							2
6-Pans longues							
Type	C/P mm	Dessin	D1 mm	D2 mm	L mm	L2 mm	

Métriques						
DO60923010	10	D	17	25	100	12
DO60923012	12	D	19,5	25	100	12
DO60923013	13	D	20,5	25	100	12
DO60923014	14	D	21,5	25	100	12
DO60923015	15	D	22,5	25	100	12
DO60923017	17	D	25	25	100	13
DO60923019	19	D	28	25	100	13
DO60924010	10	D	17	25	150	12
DO60924012	12	D	19,5	25	150	12
DO60924013	13	D	20,5	25	150	12
DO60924014	14	D	21,5	25	150	12
DO60924015	15	D	22,5	25	150	12
DO60924017	17	D	25	25	150	13
DO60924019	19	D	28	25	150	13
DO60925010	10	D	17	25	200	12
DO60925012	12	D	19,5	25	200	12
DO60925013	13	D	20,5	25	200	12
DO60925014	14	D	21,5	25	200	12
DO60925015	15	D	22,5	25	200	12
DO60925017	17	D	25	25	200	13
DO60925019	19	D	28	25	200	13

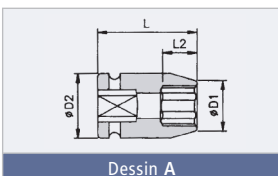

Dessin A

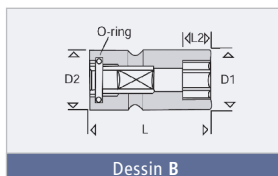

Dessin B

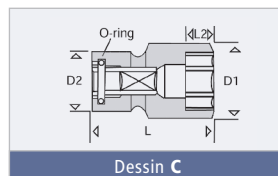

Dessin C

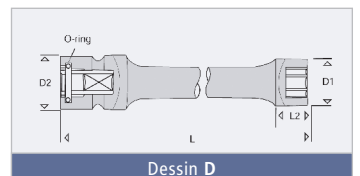

Dessin D

TAILLE							3
6-Pans longues magnétique							
Type	C/P mm	Dessin	D1 mm	D2 mm	L mm	L2 mm	

Métriques						
DO6092P010	10	D	17,5	25	100	4
DO6092P011	11	D	18,5	25	100	5
DO6092P012	12	D	20	25	100	5
DO6092P013	13	D	21	25	100	6
DO6092P014	14	D	22,5	25	100	6
DO6092P015	15	D	23,5	30	100	7
DO6092P016	16	D	25	30	100	7
DO6092P017	17	D	26	30	100	7
DO6092P018	18	D	27,5	30	100	8
DO6092P019	19	D	28,5	30	100	8

DO6092R010	10	D	17,5	25	150	12
DO6092R011	11	D	18,5	25	150	12
DO6092R012	12	D	20	25	150	12
DO6092R013	13	D	21	25	150	12
DO6092R014	14	D	22,5	25	150	12
DO6092R015	15	D	23,5	30	150	12
DO6092R016	16	D	25	30	150	13
DO6092R017	17	D	26	30	150	13
DO6092R018	18	D	27,5	30	150	13
DO6092R019	19	D	28,5	30	150	13

DO6092T010	10	D	17,5	25	200	12
DO6092T011	11	D	18,5	25	200	12
DO6092T012	12	D	20	25	200	12
DO6092T013	13	D	21	25	200	12
DO6092T014	14	D	22,5	25	200	12
DO6092T015	15	D	23,5	30	200	12
DO6092T016	16	D	25	30	200	13
DO6092T017	17	D	26	30	200	13
DO6092T018	18	D	27,5	30	200	13
DO6092T019	19	D	28,5	30	200	13

Douilles guidées

□ 1/2"

TAILLE 6-Pans normale magnétique

Type	C/P mm	Dessin	D1 mm	D2 mm	L mm	L2 mm
------	--------	--------	-------	-------	------	-------

Métriques

DO6092A006	6	A	13	25	52	5
DO6092A007	7	A	14	25	52	5
DO6092A008	8	A	15	25	52	7
DO6092A009	9	A	16	25	52	7
DO6092A010	10	A	17,5	25	52	8
DO6092A011	11	A	18,5	25	52	9
DO6092A012	12	A	20	25	52	12
DO6092A013	13	A	21	25	52	12
DO6092A014	14	A	22,5	25	52	12
DO6092A015	15	A	23,5	30	52	12
DO6092A016	16	A	25	30	52	12
DO6092A017	17	A	26	30	52	12
DO6092A018	18	A	27,5	30	52	12
DO6092A019	19	A	28,5	30	52	12
DO6092A020	20	B	30	30	52	12
DO6092A021	21	C	31	30	52	12
DO6092A022	22	C	32	30	52	12
DO6092A023	23	C	34	30	52	12
DO6092A024	24	C	35	30	52	12
DO6092A025	25	C	36	30	57	12
DO6092A026	26	C	38	30	57	12
DO6092A027	27	C	38,5	30	57	12

TAILLE 6-Pans profonde magnétique

Type	C/P mm	Dessin	D1 mm	D2 mm	L mm	L1 mm
------	--------	--------	-------	-------	------	-------

Métriques

DO6092Q010	10	A	17,5	25	100	5
DO6092Q013	13	A	21,0	25	100	6
DO6092Q016	16	A	25,0	30	100	7
DO6092Q017	17	A	26,0	30	100	7
DO6092Q019	19	A	28,5	30	100	8

TAILLE Torx® extérieure

Type	C/P	Dessin	D1 mm	D2 mm	L mm	L2 mm
------	-----	--------	-------	-------	------	-------

DO66920010	E10	A	14	25	52	7,5
DO66920011	E11	A	15	25	52	8
DO66920012	E12	A	16	25	52	8,5
DO66920014	E14	A	18	25	52	10
DO66920016	E16	A	20	25	52	11
DO66920018	E18	A	22	25	52	12,5
DO66920020	E20	A	25	30	52	14
DO66920022	E22	A	27	30	52	15
DO66920024	E24	A	29	30	52	16,5

Torx® est une marque commerciale de Textron.

TAILLE Torx® intérieure

Type	C/P	Dessin	L1 mm	D2 mm	L mm	-
------	-----	--------	-------	-------	------	---

DO68821020	T20	F	2,8	25	75	-
DO68821025	T25	F	3,0	25	75	-
DO68821027	T27	F	3,0	25	75	-
DO68821030	T30	F	3,8	25	75	-
DO68821040	T40	F	3,8	25	75	-
DO68821045	T45	F	4,3	25	75	-
DO68821047	T47	F	5,0	25	75	-
DO68821050	T50	F	5,0	25	75	-
DO68821055	T55	F	5,5	25	75	-
DO68821060	T60	F	8,0	25	75	-
DO68821070	T70	F	9,4	25	75	-
DO68821080	T80	F	10,5	25	75	-
DO68821090	T90	F	11,8	25	75	-
DO68821100	T100	F	13,1	25	75	-

Torx® est une marque commerciale de Textron.

TAILLE Empreinte 6-Pans (Inbus)

Type	C/P mm	Dessin	L1 mm	D2 mm	L mm	-
------	--------	--------	-------	-------	------	---

Métriques

DO68925003	3	F	11	25	75	-
DO68925004	4	F	11	25	75	-
DO68925005	5	F	15	25	75	-
DO68925006	6	F	15	25	75	-
DO68925007	7	F	20	25	75	-
DO68925008	8	F	25	25	75	-
DO68925009	9	F	25	25	75	-
DO68925010	10	F	25	25	75	-
DO68925011	11	F	25	25	75	-
DO68925012	12	F	25	25	75	-
DO68925013	13	F	25	25	75	-
DO68925014	14	F	25	25	75	-
DO68925015	15	F	25	25	75	-
DO68925016	16	F	25	25	75	-
DO68925017	17	F	25	25	75	-
DO68925018	18	F	25	25	75	-
DO68925019	19	F	25	25	75	-

Prise Goujon

Type	Taille	D1 mm	D2 mm	L mm
DO66A21062	M6 x 1	13	25	75
DO66A21083	M8 x 1,25	15	25	75
DO66A21104	M10 x 1,5	17	25	75
DO66A21125	M12 x 1,75	19	25	75
DO66A21146	M14 x 2	22	25	75
DO66A21166	M16 x 2	27	30	75

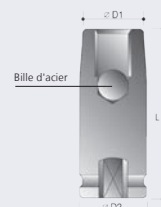

Douilles guidées

□ 3/4"



1



2



3



4



5

TAILLE 1

6-Pans normales

Type	C/P mm	Dessin	D1 mm	D2 mm	L mm	L2 mm
------	--------	--------	-------	-------	------	-------

Métriques

DO60940017	17	A	31	44	65	12
DO60940018	18	A	32	44	65	12
DO60940019	19	A	33	44	65	14
DO60940021	21	A	35	44	65	16
DO60940022	22	A	37	44	65	16
DO60940023	23	A	38	44	65	16
DO60940024	24	A	39	44	65	16
DO60940026	26	A	41	44	65	16
DO60940027	27	A	43	44	65	16
DO60940028	28	B	44	44	68	20
DO60940029	29	C	45	44	68	20
DO60940030	30	C	47	44	68	20
DO60940032	32	C	49	44	70	20
DO60940033	33	C	51	44	70	20
DO60940034	34	C	52	44	70	20
DO60940035	35	C	53	44	70	20
DO60940036	36	C	54	44	70	20
DO60940038	38	C	57	44	72	22
DO60940041	41	C	60	44	72	22
DO60940046	46	C	67	54	77	23
DO60940050	50	C	71	54	77	23

TAILLE 2

6-Pans magnétique

Type	C/P mm	Dessin	D1 mm	D2 mm	L mm	L2 mm
------	--------	--------	-------	-------	------	-------

Métriques

DO6094A013	13	A	24,5	44	65	12
DO6094A014	14	A	25,5	44	65	12
DO6094A015	15	A	27	44	65	12
DO6094A016	16	A	28	44	65	12
DO6094A017	17	A	30	44	65	12
DO6094A018	18	A	31	44	65	12
DO6094A019	19	A	32	44	65	14
DO6094A020	20	A	34	44	68	14
DO6094A021	21	A	35	44	68	16
DO6094A022	22	A	37	44	68	16
DO6094A023	23	A	38	44	68	16
DO6094A024	24	A	39	44	68	16
DO6094A025	25	A	41	44	69	16
DO6094A026	26	A	42	44	69	16
DO6094A027	27	A	43	44	69	16

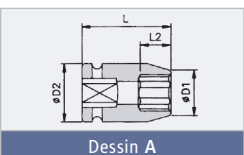

Dessin A

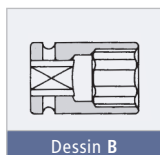

Dessin B

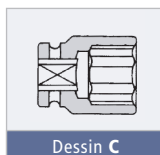

Dessin C

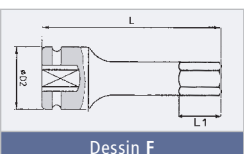

Dessin F

TAILLE 3

Empreinte 6-Pans

Type	C/P mm	Dessin	D2 mm	L mm	L2 mm	-
------	--------	--------	-------	------	-------	---

Métriques

DO68945010	10	F	44	100	20	-
DO68945012	12	F	44	100	20	-
DO68945014	14	F	44	100	20	-
DO68945016	16	F	44	100	20	-
DO68945017	17	F	44	100	20	-
DO68945019	19	F	44	100	20	-
DO68945022	22	F	44	100	20	-
DO68945024	24	F	44	100	20	-
DO68945027	27	F	44	100	20	-
DO68945030	30	F	44	100	20	-
DO68945032	32	F	44	100	20	-
DO68945033	33	F	44	100	20	-
DO68945036	36	F	44	100	20	-
DO68945038	38	F	44	100	20	-

TAILLE 4

Torx® extérieure

Type	C/P mm	Dessin	D1 mm	D2 mm	L mm	L2 mm
------	--------	--------	-------	-------	------	-------

DO66940018	E18	A	26	44	65	12,5
DO66940020	E20	A	28	44	65	14
DO66940022	E22	A	31	44	65	15
DO66940024	E24	A	33	44	65	16,5

Torx® est une marque commerciale de Textron.

Prolongateurs

5

Type	Carré d'entraînement	L mm	D2 mm
------	----------------------	------	-------

Métriques

DO64614075	3/8"	75	22
DO64614125	3/8"	125	22
DO64614250	3/8"	250	22
DO64624075	1/2"	75	25
DO64624125	1/2"	125	25
DO64624175	1/2"	175	25
DO64624250	1/2"	250	25
DO64644175	3/4"	175	44
DO64644250	3/4"	250	44
DO64644330	3/4"	330	44

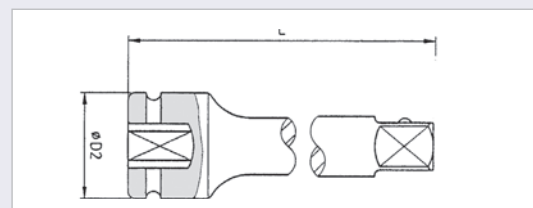

Douilles guidées

Adaptateurs

TAILLE						
Adaptateurs à changement rapide						1
Type	Embout	Tête	D2 mm	L mm	-	-
Métriques						
DO69151116	3/8"	1/2"	20	80	-	-
DO69152112	1/2"	3/8"	25	75	-	-
DO69154116	3/4"	1/2"	44	90	-	-
DO69151112	3/8"	3/8"	19	75	-	-
DO69151212	3/8"	3/8"	19	100	-	-
DO69152216	1/2"	1/2"	25	100	-	-
DO69154324	3/4"	3/4"	44	125	-	-

TAILLE						
Adaptateurs à changement rapide						2
Type	Embout carré	Mandrin 6 pans	D2 mm	L mm	-	-
Métriques						
DO69111E08	3/8"	1/4"	52	22	-	-
DO69111E14	3/8"	7/16"	62	22	-	-
DO69112E08	1/2"	1/4"	60	25	-	-
DO69112E14	1/2"	7/16"	70	25	-	-
DO69114E14	3/4"	7/16"	80	44	-	-



Action douilles guidées: réduction de la vibration

Les douilles Sleeve Drive ont été développées par Action à la demande de Yokota pour améliorer la qualité du serrage des assemblages avec les visseuses hydrotension. Les douilles guidées minimisent le jeu entre la douille et la visseuse en réduisant les oscillations et en stabilisant le réglage du couple de serrage.

Aperçu des produits:

- Douilles 6 pans
- Exécution normale ou longue
- Torx® mâle ou femelle
- Magnétique
- Douilles pour tête 6 pans intérieurs
- Carrés d'entraînement 3/8", 1/2" et 3/4"
- Adaptateurs et prolongateurs.

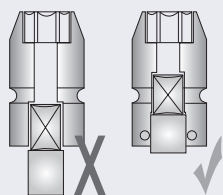

- Moins de vibration, de bruit, d'usure.
- Couples de serrage plus précis!

Jeux de douilles à choc

3/8" Jeu de douilles

DO0038-0-010

Comprend:

10 Douilles normales

9 - 10 - 11 - 12 - 13 - 14 - 15 - 16 - 17 - 19 mm

Emballage: coffret métal et alvéoles plastique



1/2" Jeu de douilles

DO0012-0-0005

Comprend:

10 Douilles normales

9 - 10 - 11 - 13 - 14 - 17 - 19 - 22 - 24 - 27 mm

Emballage: coffret métal



3/4" Jeu de douilles

DO0034-0-008

Comprend:

8 Douilles normales

24 - 27 - 30 - 32 - 33 - 36 - 38 - 41 mm

Emballage: coffret métal et alvéoles plastique



1/2" Jeu de douilles empreinte Torx®

DO69623161

Comprend:

9 Douilles à paroi mince Torx® ext.

E10 - E11 - E12 - E14 - E16 - E18 - E20 - E22 - E24

7 Douilles Torx® int. long. 55 mm

T40 - T45 - T47 - T50 - T55 - T60 - T70

Emballage: plastique moulé



1/2" Jeu de douilles, empreinte 6 pans

DO69521093

Comprend:

9 Douilles 6 pans

4 - 5 - 6 - 8 - 10 - 12 - 14 - 17 - 19 mm

Emballage: coffret métal et alvéoles plastique



1/2" Jeu de douilles, longues

DO69523108

Comprend:

10 Douilles, longues

10 - 11 - 13 - 14 - 17 - 19 - 21 - 22 - 24 - 27 mm

Emballage: plastique moulé



1" Jeu de douilles, longues

DO0100-1-007



Comprend:

7 Douilles, longues

24 - 27 - 30 - 32 - 33 - 36 - 41 mm

Emballage:

plastique moulé

Jeux de douilles à choc

1/2" Jeu de douilles spéciales pour blocage de boulon de roue

DO0012-0-286

Contents:

7 Douilles à choc, normales
17 - 18,5 - 20 - 21,5 - 23 - 24,5 - 26 mm

Emballage: plastique moulé



1/2" Jeu de douilles spéciales pour blocage de boulon de roue

DO0012-1-286

Comprend:

8 Douilles à paroi mince - longues
17 - 18,5 - 20 - 21,5 - 23 - 24,5 - 26 - 27,5 mm

Emballage: plastique moulé



Application: douilles pour dépose de boulons de roues

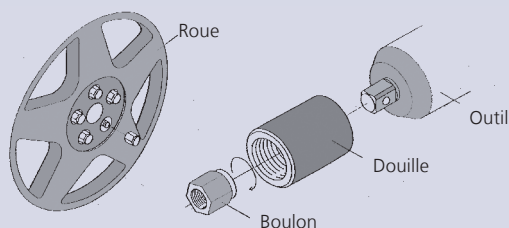

3/4" + 1" Jeu de 15 douilles réparation camion

DO69643151

Comprend:

- 1) 5 Douilles Torx® int. T60, T70, T80, T90, T100
- 2) 4 Douilles Torx® ext. E18, E20, E22, E24
- 3) 4 Douilles 6 pans int 17 - 19 - 22 - 24 mm
- 4) + Mandrin 3/4" and 1" 6 pans 22 mm + Clé 6 pans 2,5 mm

Emballage: plastique moulé

	Type	N° commande
1)	Torx® int. T60	DO697LB060
	Torx® int. T70	DO697LB070
	Torx® int. T80	DO697LB080
	Torx® int. T90	DO697LB090
	Torx® int. T100	DO697LB100
2)	Torx® ext. E18	DO697RB118
	Torx® ext. E20	DO697RB120
	Torx® ext. E22	DO697RB122
	Torx® ext. E24	DO697RB124
3)	6 Pans int. 17 mm	DO697RB017
	6 Pans int. 19 mm	DO697RB019
	6 Pans int. 22 mm	DO697RB022
	6 Pans int. 24 mm	DO697RB024
4)	Mandrin 3/4" 6 pans 22 mm	DO6054H022
	Mandrin 1" 6 pans 22 mm	DO6055N022



1/2" Jeu de douilles pour boulon de roue

DO69523183

Comprend:

9 Douilles à choc, normales
10 - 11 - 13 - 14 - 17 - 19 - 21 - 22 - 24 mm

4 Douilles à choc, longues

13 - 14 - 21 - 24 mm

3 Douilles à paroi mince, longues

17 - 19 - 21 mm

1 Cardan

1 Prolongateur 125 mm

Emballage: plastique moulé



Dynamométrique

1/2"
+ 1"

Barres limiteur de couple



Type 1/2"	C/P mm	Nm	Longueur	Couleur
DO68122D17	17	75	220	vert
DO68122L17	17	110	220	rouge
DO68122G19	19	90	220	jaune
DO68122L19	19	110	220	bleu
DO68122M19	19	135	220	gris
DO68122E21	21	80	220	noir
DO68122L21	21	110	220	brun

Type 1"	C/P mm	Nm	Longueur	-
DO68552U23	23	250	305	-
DO68552W24	24	350	305	-
DO68552W27	27	350	305	-
DO68552Z27	27	450	305	-
DO68552Y29	29	400	305	-
DO68552B30	30	550	305	-
DO68552C30	30	600	305	-
DO68552A32	32	500	305	-
DO68552C32	32	600	305	-
DO68552F32	32	700	305	-
DO68552A33	33	500	305	-
DO68552C33	33	600	305	-
DO68552C36	36	600	305	-

1/2"

Jeu de douilles pour boulon de roue extra longues

DO61120310

Comprend:

3 Douilles avec butée et manchon plastique

bleu 17 mm - jaune 19 mm - rouge 21 mm

Emballage: plastique moulé



Douilles impact aussi disponible en prises simples

Type	C/P mm	Couleur	D1 mm	D2 mm	L mm	L1 mm	L2 mm
Metrical							
DO6112J017	17	bleu	27	25	130	87	24
DO6112J019	19	jaune	29	30	130	87	24
DO6112J021	21	rouge	31	30	130	87	24
DO6112J022	22	vert	32,5	30	130	87	24

Pour la protection optimale des jantes en aluminium, douilles avec butée et manchon plastique en quatre couleurs pour faciliter l'identification.

1/2"

Jeu de douilles pour boulon de roue longues

DO69523031

Comprend:

3 Douilles avec butée et manchon plastique

bleu 17 mm - jaune 19 mm - rouge 21 mm

Emballage: plastique moulé



Douilles impact aussi disponible en prises simples

Type	C/P mm	Couleur	D1 mm	D2 mm	L mm	L1 mm	L2 mm
Metrical							
DO61126015	15	blanc	25	30	85	60	13
DO61126017	17	bleu	27	30	85	60	14
DO61126019	19	jaune	29	30	85	60	15
DO61126021	21	rouge	31	30	85	60	17
DO61126022	22	vert	32,5	30	85	60	18

Pour la protection optimale des jantes en aluminium, douilles avec butée et manchon plastique en cinq couleurs pour faciliter l'identification.

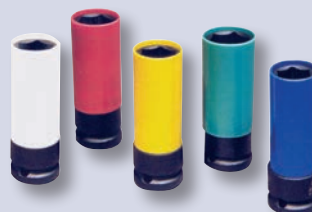



ACTION



DOGA®

Département **ASSEMBLAGE**

8 avenue Gutenberg - ZA Pariwest - BP 53 - F 78311 Maurepas Cedex

Tél. : +33 (0)1 30 66 41 48 - Fax : +33 (0)1 30 66 41 49

S.A. au capital de 2 047 200,00 € - RCS Versailles B 699 800 272 - Siret 699 800 272 00022 - NACE 4669B

www.doga.fr

Nous travaillons constamment à l'amélioration de nos produits. De ce fait, les dimensions et indications portées dans cette brochure peuvent parfois ne pas correspondre aux dernières exécutions. De convention expresse, nos ventes sont faites sous bénéfice de réserve de propriété (les dispositions de la loi du 12/5/80 trouvent donc toute leur application).



04.23.40238.11/12